

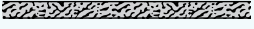

















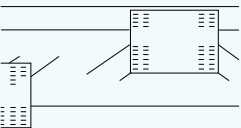



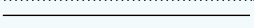

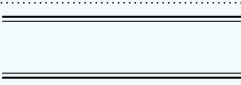
# Legend

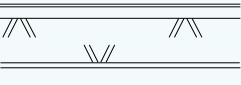
	Architectural Elements			Architectural Elements		
	Component	Cross Section	Profile	Component	Cross Section	Architectural Material Symbols
<p>This legend contains the symbols used throughout the Architectural Reference Library to represent various architectural elements. Profile and cross-section views are shown where appropriate, along with architectural material symbols.</p>	C-H studs			Polystyrene insulation		
	Z-furring			Blanket insulation		
	Engineered joist			Solid wall		
	Decking			Plywood		
	Decking			Cement board		
	Lath			Poured gypsum		
	Wood truss			Gypsum board or plaster		
	Wood joist or stud			Veneer finish		
	Steel joist or stud			Tile		
	Steel truss			Concrete or precast concrete		
	RC-1 channel			Ceiling panel		
	Furring channel					

## Steel Framed

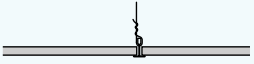

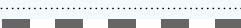
Non-loadbearing		Acoustical Performance		Fire Performance		Reference	
Construction Detail	Description	STC	Test Number	Rating	Test Number	ARL	Index
wt. 6 	<ul style="list-style-type: none"> <li>• 5/8" SHEETROCK® Brand FIRECODE® Core Gypsum Panels or IMPERIAL® Brand FIRECODE Core Abuse-Resistant Gypsum Base, FIBEROCK® Brand Panels</li> <li>– 3-5/8" 25 gauge steel studs 24" o.c.</li> <li>– joints finished</li> <li>• optional veneer plaster</li> </ul>	40	<b>USG-860808</b>	1 hour	<b>UL Des U419</b> or <b>U465</b>	SA700 SA920	<b>A-1</b>
		49	<b>SA-870717</b> Based on 3" SAFB in cavity				
		51	<b>RAL-TL-90-166</b> Based on 5/8" FIRECODE C Core panels and 3" SAFB, and veneer finish surface SAFB 25" wide, creased to fit cavity				
wt. 7 	<ul style="list-style-type: none"> <li>• 1/2" SHEETROCK Brand FIRECODE C Core Gypsum Panels</li> <li>– 2-1/2" 25 gauge steel studs 24" o.c.</li> <li>– 1-1/2" THERMAFIBER SAFB</li> <li>– joints finished</li> </ul>	41	<b>RAL-TL-69-148</b> Based on same construction without THERMAFIBER SAFB	1 hour	<b>UL Des U419</b> or <b>U448</b>	SA920	<b>A-2</b>
		50	<b>SA-800504</b>				
wt. 7 	<ul style="list-style-type: none"> <li>• Face layer 1/2" SHEETROCK Brand FIRECODE C Core Gypsum Panels</li> <li>– 1-5/8" 25 gauge steel studs 24" o.c.</li> <li>• base layer 1/4" SHEETROCK Brand Gypsum Panels</li> <li>– joints finished</li> </ul>	53	<b>CK-684-13</b> Based on 1-1/2" mineral wool batt and 2-1/2" studs	1 hour	<b>GA-WP-1090</b>		<b>A-3</b>
wt. 7 	Alternate based on 2-1/2" 25 gauge steel studs and 1/2" face layer laminated	53	<b>NGC-2318</b> Based on 2" glass fiber	1 hour	<b>GA-WP-1051</b>		<b>A-4</b>
wt. 5 	<ul style="list-style-type: none"> <li>• 1/2" SHEETROCK Brand FIRECODE C Core Gypsum Panels</li> <li>– 3-5/8" 25 gauge steel studs 24" o.c.</li> <li>– 3" THERMAFIBER SAFB</li> <li>– RC-1 channel or equivalent one side spaced 24" o.c.</li> <li>• optional veneer plaster</li> </ul>	50	<b>RAL-TL-87-156</b>	1 hour	<b>UL Des U419</b> or <b>U451</b>	SA920	<b>A-5</b>
		54	<b>RAL-TL-83-216</b> Based on 5/8" thick panels				
clg. wt. 5 	<ul style="list-style-type: none"> <li>• 1/2" SHEETROCK Brand FIRECODE C Core Gypsum Panels</li> <li>– 6" 20 gauge steel studs 24" o.c.</li> <li>– 5" THERMAFIBER SAFB</li> <li>– RC-1 channel or equivalent one side spaced 24" o.c.</li> </ul>	56	<b>RAL-TL-87-139</b>	1 hour	<b>UL Des U419</b> or <b>U451</b>	SA920	<b>A-6</b>
		56	<b>RAL-TL-84-141</b> Based on 5/8" thick SHEETROCK Brand FIRECODE C Core Gypsum Panels				
wt. 14 	<ul style="list-style-type: none"> <li>• 1/2" DUROCK Brand Cement Board and 1/4" ceramic tile</li> <li>– 3-5/8" 20 gauge steel studs 16" o.c.</li> <li>– 3" THERMAFIBER SAFB</li> <li>– alternate design 5/8" SHEETROCK Brand FIRECODE Core Gypsum Panels, one side</li> </ul>	48	<b>SA-840321</b>	1 hour	<b>UL Des U442</b>	SA934	<b>A-7</b>
		50	<b>SA-840313</b> Based on alt design				

# A

# Partitions

## Steel Framed



Non-loadbearing		Acoustical Performance		Fire Performance		Reference	
Construction Detail	Description	STC	Test Number	Rating	Test Number	ARL	Index
wt. 7 	<ul style="list-style-type: none"> <li>• 1/2" SHEETROCK Brand FIRECODE C Core Gypsum Panels</li> <li>– 3-5/8" 20 gauge studs 24" o.c.</li> <li>– 3" THERMAFIBER SAFB</li> <li>– RC-1 channel or equivalent one side spaced 24" o.c.</li> <li>– 2 layers gypsum panels</li> <li>– face layer joints finished</li> <li>• optional veneer plaster</li> </ul>	58	<b>RAL-TL-83-215</b>	1-1/2 hour	<b>UL Des U452</b>	SA920	<b>A-8</b>
		59	<b>RAL-TL-84-140</b> Based on 3-5/8" stud assembly without mineral wool batt				
wt. 9 	<ul style="list-style-type: none"> <li>• 1/2" SHEETROCK Brand FIRECODE C Core Gypsum Panels each side</li> <li>– 1-5/8" 25 gauge steel studs 24" o.c.</li> <li>– face layer joints finished</li> <li>• optional veneer plaster</li> </ul>	50	<b>USG-840817</b> Based on 3-5/8" stud assembly without mineral wool batt	2 hour	<b>UL Des U419</b> or <b>U412</b>	SA920	<b>A-9</b>
		52	<b>SA-860932</b> Based on lamin. face layer, 1-1/2" mineral wool batt and 2-1/2" studs				
		54	<b>CK-654-40</b> Based on 2-1/2" studs, screw-attached face layer and 1-1/2" mineral wool batt				
		55	<b>SA-800421</b> Based on 3-5/8" studs and 1-1/2" mineral wool batt				
wt. 11 	<ul style="list-style-type: none"> <li>• 5/8" SHEETROCK Brand FIRECODE Core Gypsum Panels, or FIBEROCK Brand Panels</li> <li>– 1-5/8" 25 gauge steel studs 24" o.c.</li> <li>– face layer joints finished</li> <li>• optional veneer plaster</li> </ul>	48	<b>BBN-770408</b> Based on 3-5/8" studs and 5/8" SHEETROCK Brand FIRECODE C Core Gypsum Panels	2 hour	<b>UL Des U419</b> or <b>U411</b>	SA920	<b>A-10</b>
		56	<b>USG-840818</b> Based on 3-5/8" studs and 3" mineral wool batt				
wt. 7 	<ul style="list-style-type: none"> <li>• 3/4" SHEETROCK Brand ULTRACODE Core Gypsum Panels</li> <li>– 3-1/2" 25 gauge steel studs 24" o.c.</li> <li>– 3" THERMAFIBER SAFB</li> <li>– joints finished</li> </ul>	50	<b>USG-910617</b>	2 hour	<b>UL Des U419</b> or <b>U491</b>		<b>A-11</b>
wt. 7 	<ul style="list-style-type: none"> <li>• 1/2" SHEETROCK Brand FIRECODE C Core Gypsum Panels</li> <li>– 3-5/8" 20 gauge studs 24" o.c.</li> <li>– 3" THERMAFIBER SAFB</li> <li>– RC-1 channel or equivalent one side spaced 24" o.c.</li> <li>– single-layer gypsum panels screw-attached to studs</li> <li>– double layer screw-attached to channel</li> <li>– face layer joints finished</li> <li>• optional veneer plaster</li> </ul>	59	<b>RAL-TL-84-136</b> Based on 5/8" thick panels, 6" 20 gauge structural studs, 5" mineral wool batt	2 hour	<b>UL Des U419</b> or <b>U453</b>	SA920	<b>A-12</b>
		60	<b>RAL-TL-87-140</b> Based on 1/2" thick panels, 6" 20 gauge structural studs, 5" mineral wool batt				

# A

# Partitions

## Wood Framed



Loadbearing		Acoustical Performance		Fire Performance		Reference	
Construction Detail	Description	STC	Test Number	Rating	Test Number	ARL	Index
<p>wt. 7 4 3/4"</p>	<ul style="list-style-type: none"> <li>• 5/8" SHEETROCK Brand FIRECODE Core Gypsum Panels or FIBEROCK Brand Panels</li> <li>– 2x4 wood stud 16" or 24" o.c.</li> <li>– joints finished</li> <li>• optional veneer plaster</li> </ul>	34	<b>USG-30-FT-G&amp;H</b> Based on 16" stud spacing and screws 6" o.c.	1 hour	<b>UL Des U305, U314</b>	SA920	<b>A-25</b>
		37	<b>USG-860807</b> Based on 24" stud spacing				
		46	<b>BBN-700725</b> Based on 24" stud spacing and 3" mineral wool batt				
<p>wt. 7 5 1/4"</p>	<ul style="list-style-type: none"> <li>• 5/8" SHEETROCK Brand FIRECODE C Core Gypsum Panels</li> <li>– 2x4 wood stud 16" or 24" o.c.</li> <li>– 3" THERMAFIBER SAFB</li> <li>– RC-1 channel or equivalent one side</li> <li>– joints finished</li> </ul>	50	<b>BBN-760903</b>	1 hour	<b>UL Des U327</b>		<b>A-26</b>
<p>wt. 12 6"</p>	<ul style="list-style-type: none"> <li>• 5/8" SHEETROCK Brand FIRECODE Core Gypsum Panels or SHEETROCK Brand Water-Resistant FIRECODE Core Gypsum Panels or FIBEROCK Brand Panels</li> <li>– 2x4 wood studs 16" o.c.</li> <li>– joints finished</li> <li>• optional veneer plaster</li> </ul>	52	<b>USG-810218</b> Based on same assembly (non-fire rated) with RC-1 channel and without mineral wool batt	2 hour	<b>UL Des U301</b>	SA920	<b>A-27</b>
		58	<b>USG-810219</b> Based on same assembly with RC-1 channel and 2" mineral wool batt				
<b>Chase Walls</b>							
<p>12 1/4"</p>	<ul style="list-style-type: none"> <li>• 1/2" SHEETROCK Brand FIRECODE C Core Gypsum Panels, both outside both walls double layer and inside single layer</li> </ul>	57	<b>RAL-TL-73-224</b> 3-1/2" glass fiber	1 hour	<b>GA-WP-3810</b>		<b>A-28</b>
		51	<b>RAL-TL-69-214</b>				
<p>10 1/2"</p>	<ul style="list-style-type: none"> <li>• 5/8" SHEETROCK Brand FIRECODE Core Gypsum Panels, or FIBEROCK Brand Panels</li> <li>– 2 rows 2x4 wood studs 16" o.c. on separate plates 1" apart</li> <li>– joints finished</li> </ul>	56	<b>USG-710120</b> Based on 3-1/2" thick insulation in one cavity	2 hour	<b>GA-WP-3820</b>		<b>A-29</b>
		58	<b>GA-NGC-3056</b>				
		47	<b>RAL-TL-69-211</b>				
<p>8"</p>	<ul style="list-style-type: none"> <li>• 5/8" SHEETROCK Brand FIRECODE C Core Gypsum Panels or FIBEROCK Brand Panels</li> <li>– 2x4 wood studs 16" o.c. on 2x6 common plate</li> <li>– joints finished</li> </ul>	51	<b>GA-NGC-2377</b>	2 hour	<b>GA-WP-3910</b>		<b>A-30</b>

# B

# Floor/Ceilings

## Wood Framed



Dimensional Lumber		Acoustical Performance			Fire Performance		Reference	
Construction Detail	Description	STC	IIC	Test Number	Rating	Test Number	ARL	Index
	<ul style="list-style-type: none"> <li>• 2 layers 5/8" SHEETROCK Brand FIRECODE C Core Gypsum Panels</li> <li>– 8" x 8" ceramic tile</li> <li>• 1/2" DUROCK Brand Exterior Cement Board</li> <li>• 1" SHEETROCK Brand Gypsum Liner Panels</li> <li>– 1/2" plywood</li> <li>– 2x10 wood joist 16" o.c.</li> <li>– 3" mineral wool batt</li> <li>– RC-1 channel or equivalent</li> </ul>	58	52	<b>RAL-IN-89-5</b>	2 hour	<b>UL Des L541</b>	SA934	<b>B-9</b>
		59	51	<b>RAL-IN-89-7</b>				
		59		<b>RAL-TL-89-145</b> Based on vinyl tile over oriented strand board in place of ceramic tile and cement board				
		60		<b>RAL-TL-89-146</b> Based on carpet/pad over oriented strand board in place of ceramic tile and cement board				
		62		<b>RAL-TL-89-141</b>				
	<ul style="list-style-type: none"> <li>• 2 layers 5/8" SHEETROCK Brand FIRECODE C Core Gypsum Panels</li> <li>– 2x10 wood joists 16" o.c.</li> <li>– 3" mineral wool batt</li> <li>– RC-1 channel or equivalent</li> </ul>	59		<b>RAL-TL-90-40</b>	2 hour	<b>UL Des L541</b>		<b>B-10</b>
		69		<b>RAL-IN-90-5</b>				
		59		<b>RAL-TL-90-40</b> Based on vinyl tile in place of carpet/pad				
		37		<b>RAL-IN-90-6</b>				
<b>Engineered Joist</b>								
	<ul style="list-style-type: none"> <li>• 5/8" SHEETROCK Brand FIRECODE C Core Gypsum Panels, ceiling</li> <li>– 3/4" T&amp;G plywood</li> <li>– I-shaped wood joist 24" o.c.</li> <li>– metal furring channel 24" o.c.</li> <li>– 1-1/4" 8 pcf THERMAFIBER insulation (UL Des 531)</li> <li>– joints finished</li> <li>• optional 3/4" LEVELROCK Brand Floor Underlayment</li> <li>• optional SRM-25 or SRB sound mat</li> </ul>	47	40	<b>RAL-TL-81-87</b> <b>RAL-IN-81-16</b>	1 hour	<b>UL Des L530</b> based on 9-1/2" deep TJI® joists	SA305	<b>B-11</b>
		54		<b>RAL-IN-81-17</b> Based on carpet and pad atop flooring				
		43		<b>RAL-IN-81-19</b> Based on cushioned vinyl atop flooring				
	<ul style="list-style-type: none"> <li>• 2 layers 1/2" SHEETROCK Brand FIRECODE C Core Gypsum Panels</li> <li>• optional SRM-25 or SRB sound mat</li> <li>– 19/32" wood subfloor</li> <li>– 9-1/2" deep "I" shaped wood joist 24" o.c.</li> <li>– 14" parallel chord wood truss 32" o.c.</li> <li>– RC-1 or equivalent</li> <li>• 3/4" LEVELROCK Brand Floor Underlayment</li> </ul>	64	58	<b>RAL-OT03-05/06</b> 1" LEVELROCK, vinyl, SRM-25, 3-1/2" insulation	1 hour	<b>UL Des L570</b>	SA305	<b>B-12</b>
		64	62	<b>RAL-OT03-07/08</b> 1" LEVELROCK, engineered wood-laminate floor, SRM-25, 3-1/2" insulation				
		66	54	<b>RAL-OT03-09/10</b> 1" LEVELROCK, ceramic tile, SRM-25, 3-1/2" insulation				
		65	54	<b>RAL-OT03-01/02</b> 3/4" LEVELROCK, vinyl, SRB, 3-1/2" insulation				
		66	51	<b>RAL-OT03-03/04</b> 3/4" LEVELROCK, ceramic tile, SRB, 3-1/2" insulation, crack isolation membrane				

# Design Details

## Wood Framed

**Sound isolating partition**

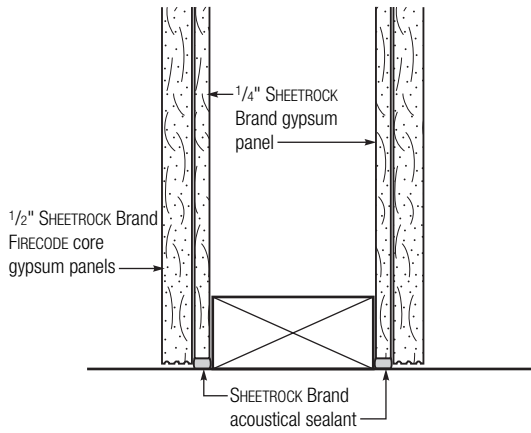

**Sound isolating partition — chase wall**

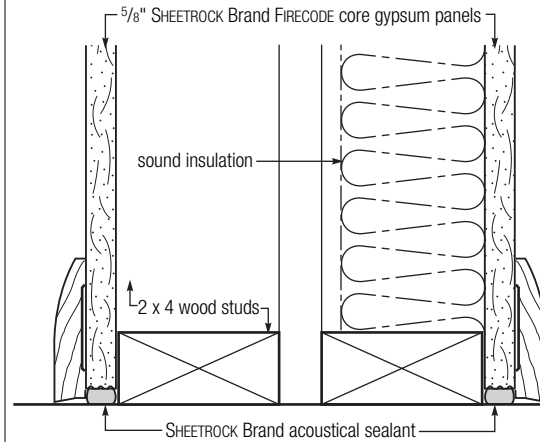

**Ceiling/floor attachment — SHEETROCK Brand gypsum panel**

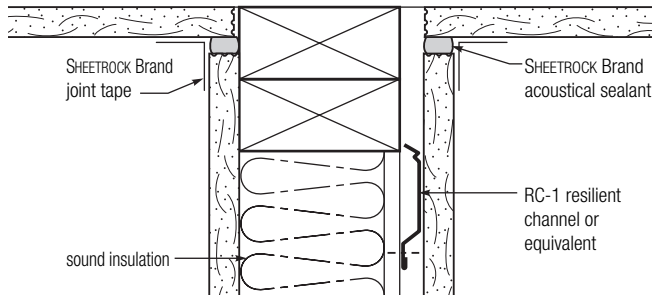

**Ceiling/floor attachment/SHEETROCK Brand gypsum panel, FIRECODE C Core panel**

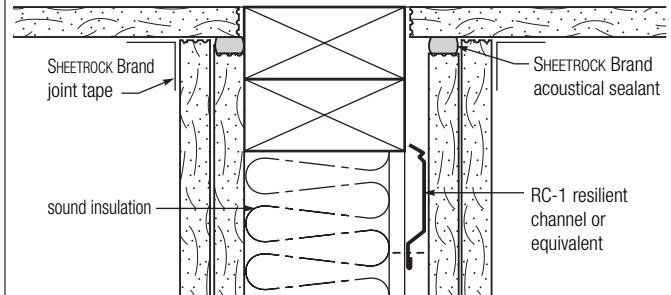

**Floor attachment**

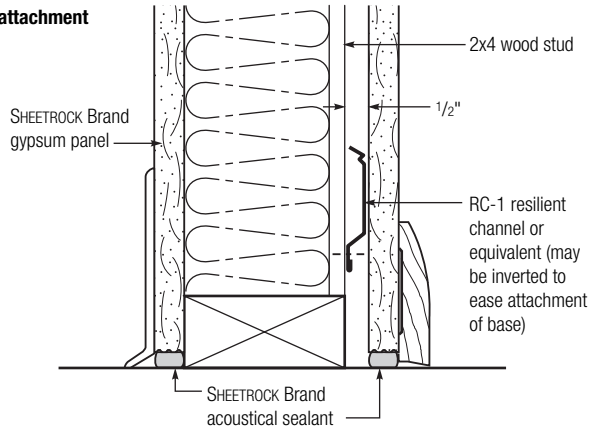

**Floor attachment**

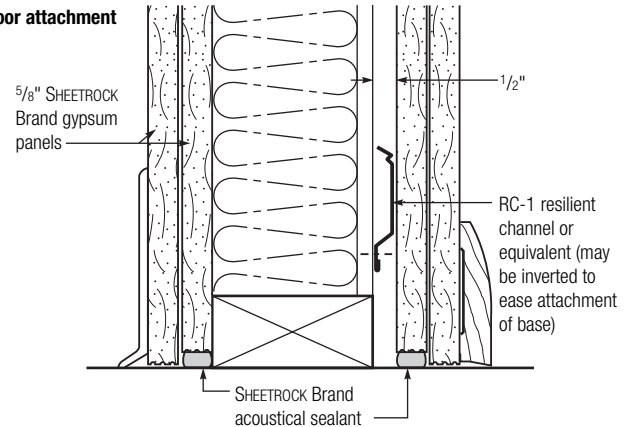

# Design Details

## Wood Framed

**Single-layer panels with RC-1 Channel**

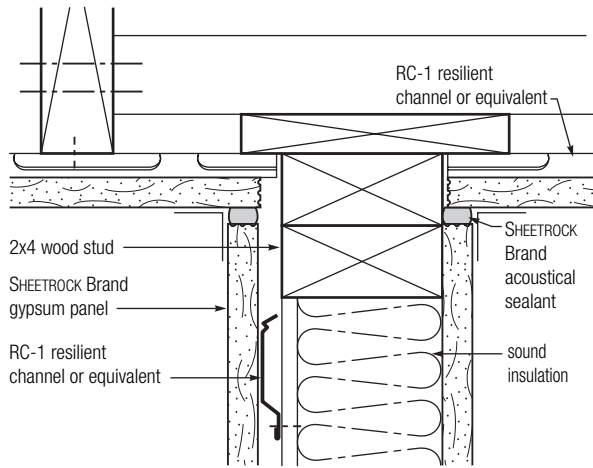

**Double-layer panels with RC-1 Channel**

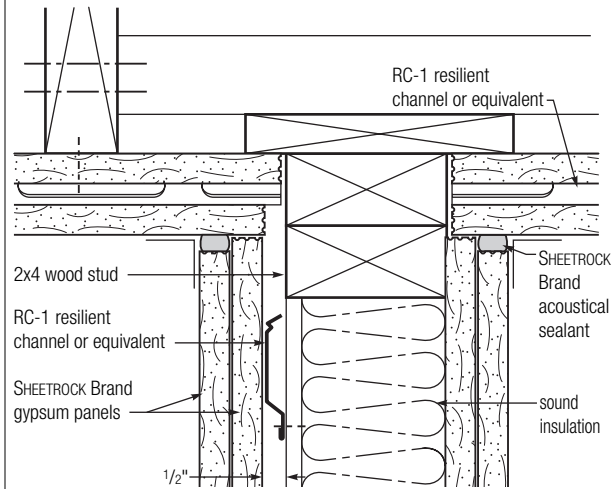

**Ceiling and floor assemblies**

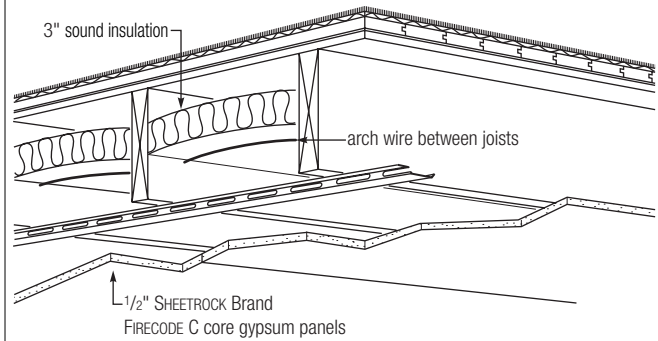
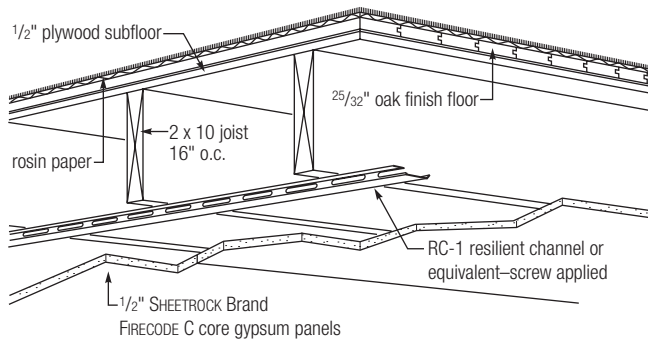

**Ceramic tile**

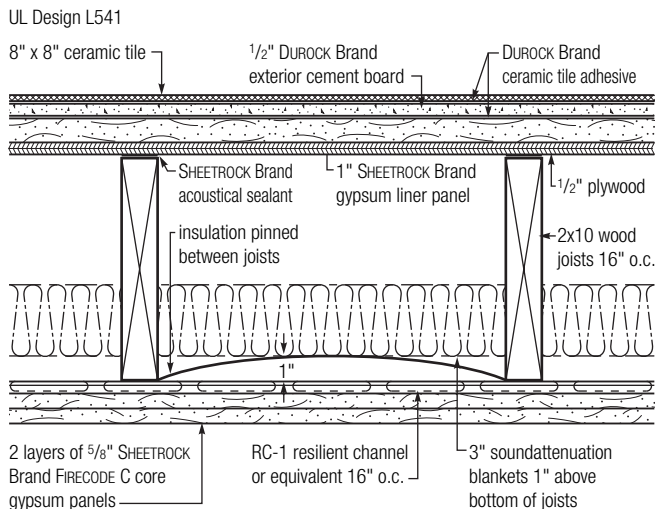

**Vinyl tile or carpet/pad**

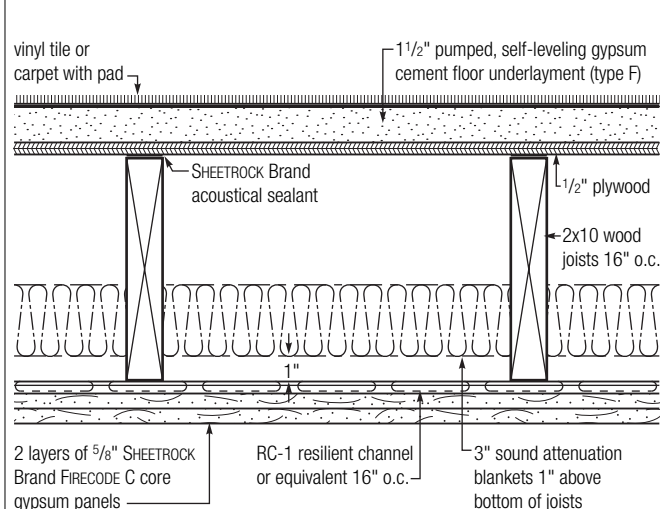

## Steel Framed

### Corner wall partition

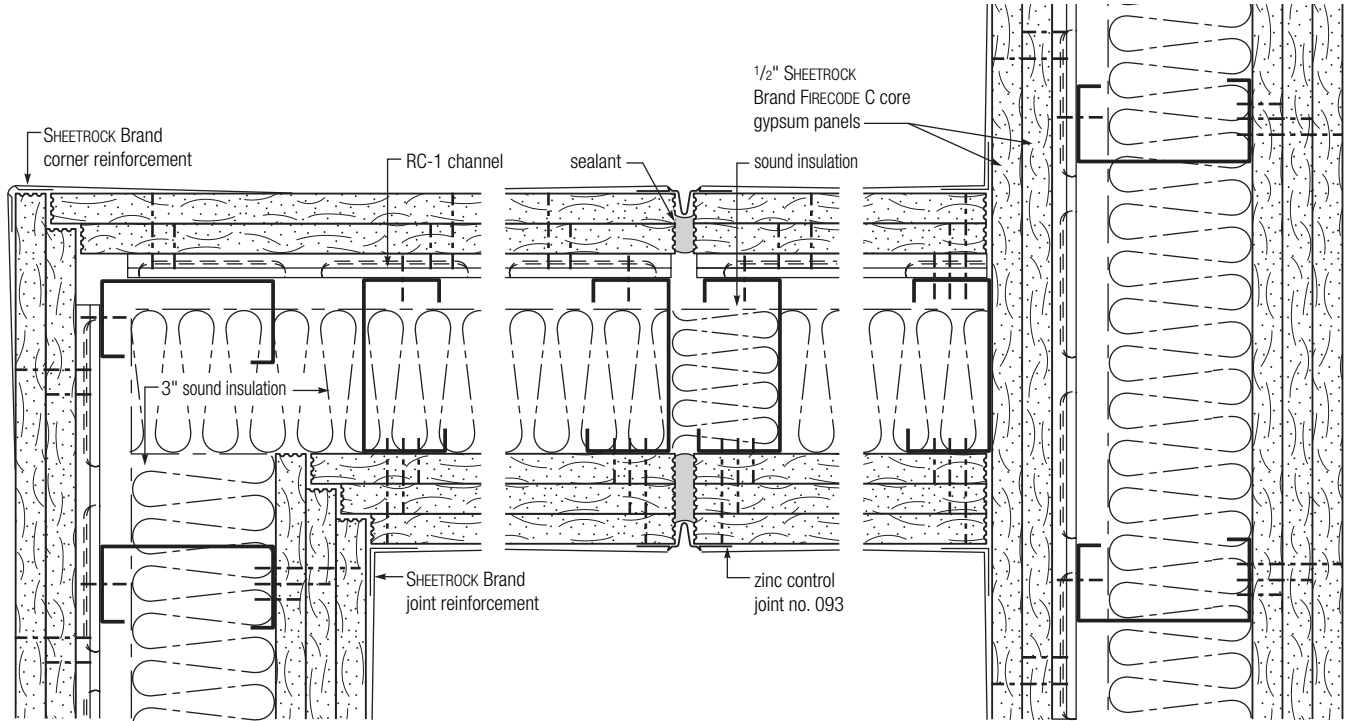

### Sound isolating interrupted ceiling

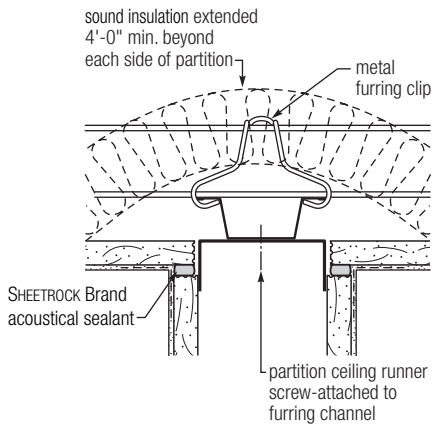



## Interrupting Flanking Paths

**Resilient Channel Wall Framing – Avoid**

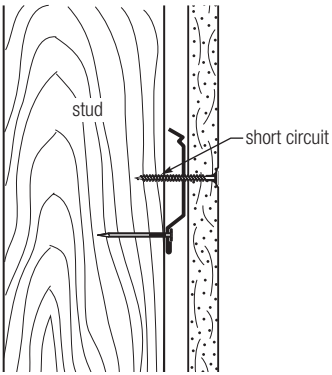

**Resilient Channel Wall Framing – Recommended**

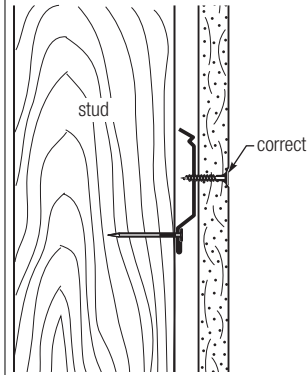

**Electrical Boxes – Avoid**

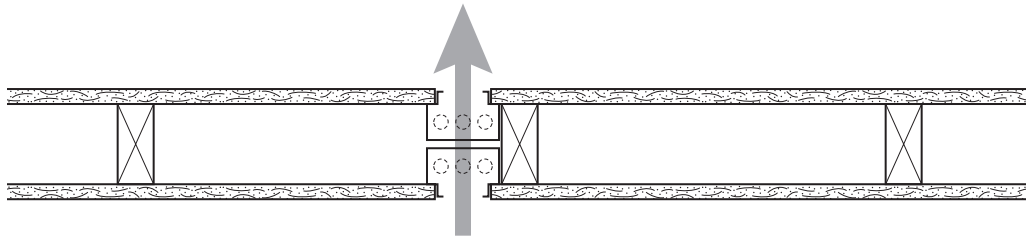

**Electrical Boxes – Better**

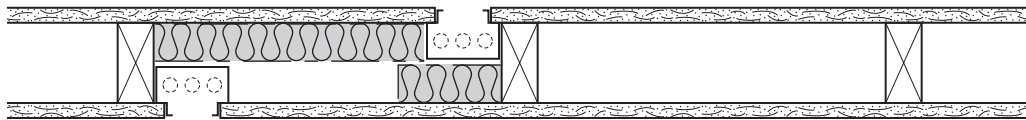

**Electrical Boxes – Recommended**

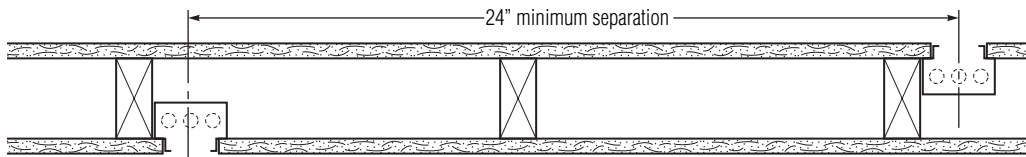

**Cabinet Cutout**

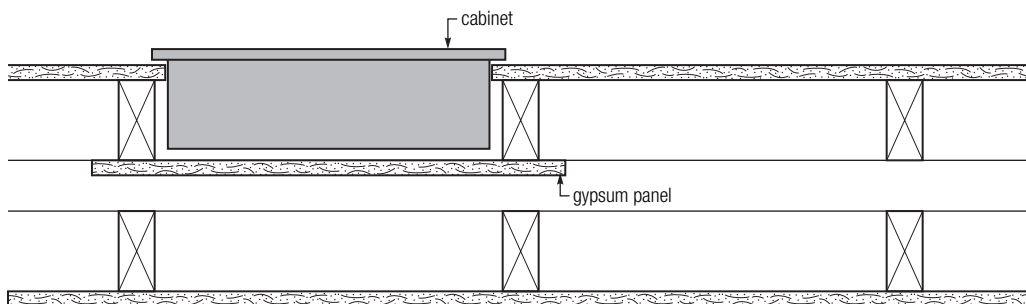

# Good Design Practices

---

In most building design, the No. 1 acoustical goal is to specify wall partitions, ceiling systems and floor/ceiling assemblies that will minimize transmission of airborne and impact sound beyond their areas of origin. This performance can be achieved with a combination of materials, assembly designs and construction methods tested for acoustical performance on a variety of parameters. Here is an overview of design strategies for key components that can make spaces more pleasant, comfortable and productive.

---

## Ceilings

### **Absorb Sound in Open Spaces**

Select high-NRC ceiling panels for open areas to absorb a significant amount of the sound generated within these spaces. Acoustics are further improved with partitions having high STC values to help block sound and prevent transmission across large spaces.

### **Block Sound in Enclosed Spaces**

Choose high-CAC ceiling panels for private offices, meeting rooms and other enclosed areas to block sound from traveling up into the plenum and out to adjacent spaces. This approach will reduce distractions for those outside and improve speech privacy for those within.

### **Cover Sound in All Areas**

Sound masking covers noise that is not absorbed or blocked by introducing uniform, ambient, background sound into the space. Sound masking produces an electronic sound spectrum similar to that of softly blowing air; it is amplified through speakers above the suspended ceiling to unobtrusively raise the background sound level. Sound masking makes noise in open spaces less distracting, increases speech privacy in enclosed spaces and provides greater acoustical balance throughout.

---

## Walls

### **Increase mass**

As partition mass increases, sound waves lose more energy passing through the medium, reducing their ability to vibrate air on the other side. Relying on mass alone, however, poses limitations. Doubling the mass of a partition can reduce sound transmission by up to 5 dB. Thus, achieving a 60 dB reduction would require total mass of 320 pounds per square foot, the equivalent of approximately 3' of solid concrete, not a feasible solution for most building designs.

### **Enlarge air spaces**

Isolating air space within a partition can increase STC performance. But like increasing mass, performance increases are limited. Doubling partition air space can reduce sound transmission by up to 5 dB, so achieving a 60 dB reduction would require an isolated air space 4' wide, hardly practical for most applications.

---

**Add sound insulation**

Adding a layer of fibrous sound-absorbing insulation material such as mineral wool into the partition cavity will dissipate sound by creating friction, which transforms a portion of sound wave energy into heat. However, sound attenuation blankets cannot completely counter the conductivity of the wood or steel studs in the framing assembly, which provide a path of least resistance for sound energy.

---

**Decouple wall panels**

Attaching the wall surface diaphragm (e.g. drywall panels) directly to framing members provides an uninterrupted path for sound travel. This route can be interrupted by mounting the surface diaphragm to resilient channels attached to the wall studs and placing sound insulation inside the partition cavity.

---

**Seal flanking paths**

Closing off gaps or penetrations in the wall assembly is critical to controlling noise. One of the most effective methods is to apply acoustical sealant at the intersection of the gypsum panel, floor system (wood or concrete), and the leg of the steel runner or wood sole plate; sealant should be applied at this location on both sides of the partition. A properly sealed wall assembly with one 5/8" gypsum panel on each side and a 1-1/2" thick sound attenuation blanket installed in the air cavity achieves an STC of 53. Without acoustical sealant, this assembly would produce an STC of only 29—a dramatic 45 percent reduction.

---

**Increase isolation with steel studs**

A single-layer partition with 5/8" gypsum panels and 3-5/8" stud achieves 40 STC with 25-ga. steel and 38 STC with 20-ga. steel. STC falls to 35 with a traditional 2' x 4' stud due to the greater stiffness of wood.

---

**Floor/Ceiling Assemblies****Isolate sound**

Whether constructed with joists, trusses or concrete slabs, floor systems can develop gaps or cracks, providing a flanking path for sound to travel between levels of a building. Even properly sealed assemblies can transmit noise from footsteps, falling objects, closing doors and other impacts. These acoustical problems can be significantly reduced with a flooring system that includes a layer of sound absorbing material topped with a poured cementitious underlayment. The poured underlayment finds and seals cracks and other sound channels, then hardens to form a solid barrier isolated from the structure below by the sound mat or board. This system can provide STC ratings as high as 66 and increase IIC by as much as 13 points, a significant improvement.

# STC Guidelines

Building Type	Room	Adjacent Room Room	STC			
			Minimum <sup>d</sup>	Medium	High	
Residential, including motels, hospitals, and dormitories	Bedroom	Bedroom	45	50	55	
		Living room	50	55	60	
		Kitchen	50	55	60	
		Bathroom	50	55	60	
		Corridor	45	50	55	
		Lobby	50	55	60	
	Mech. room	55	60	60+		
	Living Room	Living room	40	45	55	
		Kitchen	45	50	60	
		Bathroom	45	50	60	
		Corridor	45	45	55	
		Lobby	50	55	60	
		Mech. room	50	60	60+	
	Kitchen or Bathroom	Kitchen	40	45	50	
		Bathroom	40	45	50	
		Corridor	40	40	50	
		Lobby	45	50	60	
		Mech. room	45	55	60+	
	Business	Office	Office	45	50	55
			General area	40	45	50
			Corridor	40	45	50
Washroom			45	50	55	
Kitchen			45	50	55	
Conference room			45	50	55	
Conference Room		General area	40	45	50	
		Corridor	40	40	45	
		Washroom	40	45	50	
		Kitchen	45	50	55	
		Conference room	40	45	50	
General Area		Corridor	40	40	45	
		Washroom	40	45	50	
		Kitchen	45	50	55	
School		Classroom	Classroom	45	50	55
	Laboratory		45	50	55	
	Corridor		40	40	45	
	Kitchen		50	55	55	
	Shop		55	60	60	
	Recreation area		45	50	55	
	Music room		60	60	60	
	Mech. room		50	55	60	
	Washroom		45	50	55	
	Music Room	Laboratory	45	50	55	
		Corridor	45	50	55	
		Shop	50	55	60	
		Recreation area	50	55	60	
		Music room	55	60	60	
Mech. room	50	55	60			

**Note**

(d) Current model building codes require a minimum STC (and IIC) separation of dwelling units. The 2003 International Building Code requires a minimum separation of 50 STC and 50 IIC for apartments, condominiums and townhouses. Local jurisdictions using the 2003 International Residential Code may require a minimum separation of 45 STC for townhouses.