

A PRACTICAL GUIDE TO MODERN WOOD HEATING



Successful Conversion to Wood Heating for
AFFORDABLE HOUSING IN VERMONT

Prepared by the Vermont State Wood Energy Team with funding from the USDA Forest Service



A Practical Guide To Modern Wood Heating: Successful Conversion to Wood Heating for Affordable Housing in Vermont

AUTHORS

Adam Sherman, Juliette Juillerat, and Rabi Vandergon
Biomass energy Resource Center at VEIC

ACKNOWLEDGMENTS

With special thanks for review and contributions from:

Paul Frederick
Vermont Department of Forests, Parks and Recreation

Lew McCreery
USDA Forest Service

Rob Clark
USDA Forest Service

Dan Wilson
Wilson Engineering Services

DISCLAIMER

The work upon which this publication is based was funded in whole or part through a cooperative agreement with the USDA Forest service. USDA is an equal opportunity provider and employer. The information contained herein creates no warranty either expressed or implied. The USDA Forest Service, its officers, employees, and project partners assume no liability for its contents or the use thereof. Use of this information is at the sole discretion of the user.

In accordance with Federal law and U.S. Department of Agriculture Policy, this institution is prohibited from discriminating on the basis of race, color, national origin, sex, age, or disability. (Not all prohibited bases apply to all programs.)

To file a complaint alleging discrimination, write USDA, Director, Office of Civil Rights, 1400 Independence Avenue, SW, Washington DC 20250-9410 or call toll free voice (866) 632-9992, TDD (800) 877-8339, or voice relay (866) 377-8643. USDA is an equal opportunity provider and employer.

Published September, 2017

Cover photo courtesy Matt Shalvatis

Contents

Foreword	i
1 Why Modern Wood Heating?	1
2 Comparing Heating Fuel Costs	5
3 Wood Heating Fuels	7
4 Modern Wood Heat Technology	18
5 Modern Wood Heat System Design Considerations	31
6 System Operation and Maintenance	43
7 Economic Performance	47
8 Project Implementation	54
9 Resources Available to Affordable Housing Providers	59
Case Study: Housing Trust of Rutland County	65
Glossary	67

Foreword

This guidebook serves as a technical reference for affordable housing providers who are looking for lower-cost, more predictable, stable, and local energy sources for heating. Its purpose is to increase awareness of the viability of modern wood heating and to help ensure potential projects employ best in class technology and best design and management practices. The guide is both a general and a technical resource. The guide covers woodchip, wood pellet, and cordwood fuels and heating systems.

This guidebook is intended to be a reference for potential owners of institutional-scale modern wood heating systems, such as multifamily building owners and managers. The Wildland Fire Hazardous Fuels- Statewide Wood Energy Team (SWET) program of the U.S. Forest Service, Department of Agriculture provided funding and guidance for this publication.

Vermont SWET

The Vermont Statewide Wood Energy Team (SWET) is a partnership of the USFS, the State of Vermont and several organizations — the Biomass Energy Resource Center, Housing Vermont, Renewable Energy Vermont, and the School Energy Management Program of the VT Superintendents' Association. The partnership provides outreach and technical support to schools and providers of affordable housing, for the successful conversion to modern wood heating systems as a strategy to help lower energy costs, boost the Vermont economy, sustain the forested working landscape, and reduce carbon emissions.

For further information on the Vermont SWET, please contact:

Paul Frederick
VT State Wood Energy Team Manager
VT Department of Forests, Parks & Recreation
1 National Life Drive, Davis 2
Montpelier, VT 05620-3801
Phone: 802-777-5247
paul.frederick@vermont.gov



1 Why Modern Wood Heating?

Many building owners in Vermont use fossil fuels, such as oil or propane, for space heating and for domestic hot water. Imported fossil fuels have historically been expensive and their prices continue to be very volatile. Additionally, burning fossil fuels emits large amounts of greenhouse gases that accelerate climate change. An over-dependence on imported fossil fuel also reduces the self-sufficiency of local communities. Proven alternatives to fossil fuels exist and are already in use.

Wood heating fuels are a local, affordable resource for providing reliable heat.

This chapter reviews the main reasons why an affordable housing facility should consider modern wood heat.

Support the Local Economy: Heat Local

Money spent on oil and gas drains local economies sending heating dollars out of the region. Using local wood for heating can lead to increased economic opportunity in the region and state by keeping heating energy dollars in the local economy, and by creating and sustaining jobs in the forestry and forest products industries. Increased demand for wood heating fuels helps create vital markets for low-grade wood, improving the economic viability of sustainable forest management and supporting local economies with additional purchases and jobs.

Experience Low and Predictable Energy Costs

Perhaps the greatest advantage of wood fuels like chips, pellets, and cordwood is that they cost, on average over time, 25 to 75 percent less than fossil fuels used for heating. Pricing has also been much more stable over time. Over the last 30 years wood fuel prices have risen very gradually while fossil fuel prices continue to rise and fall unpredictably (see [Chapter 2 – Comparing Heating Fuel Costs](#) for details).

Reduce Your Carbon Footprint

Carbon dioxide (CO₂) is a significant greenhouse gas contributing to global climate change. Fossil fuel combustion releases geologic carbon that has been locked away underground for millions of years (as crude oil and gas) into the atmosphere as CO₂. In contrast, carbon associated with wood is part of the ongoing forest carbon cycle where trees remove CO₂ from the atmosphere, store it as carbon in wood, and release it back to the atmosphere when wood is burned. It is therefore part of the short-term natural carbon cycle between forests and the atmosphere.

As long as forests remain healthy and are sustainably harvested, the net effect of burning wood fuel is that little or no new CO₂ is added to the atmosphere. When wood fuels are sourced from sustainably managed forests and used to replace fossil fuels for space heating, it is an effective strategy for mitigating global climate change.



Heat with Clean, Convenient, and Efficient Systems

Over the past decade, wood combustion technology has advanced dramatically – resulting in higher efficiencies, lower emissions, and overall greater ease of use. Modern wood fueled hydronic heating systems (i.e. boilers) emit far less particulate matter (PM) than older wood heating technology from just ten years ago (for more details, see [Chapter 5 – Modern Wood Heat System Design Considerations, Emissions from Wood and Fossil Fuels](#)).

Reduce Your Environmental Risk

Aging underground tanks can leak, contaminating the soil adjacent to buildings and posing a threat to ground and surface waters.

Lead by Example

Today, Vermont leads the nation in our use of modern wood heating for schools, multi-family housing, hospitals, college campuses, office buildings and single family homes. For example, more than a third of our public K-12 square footage and over 3% of our multi-family square footage is heated with wood (Figure 1 and Figure 2 below). The rest is heated with fossil fuels. Despite our leadership, we remain highly dependant on fossil fuels for heat.

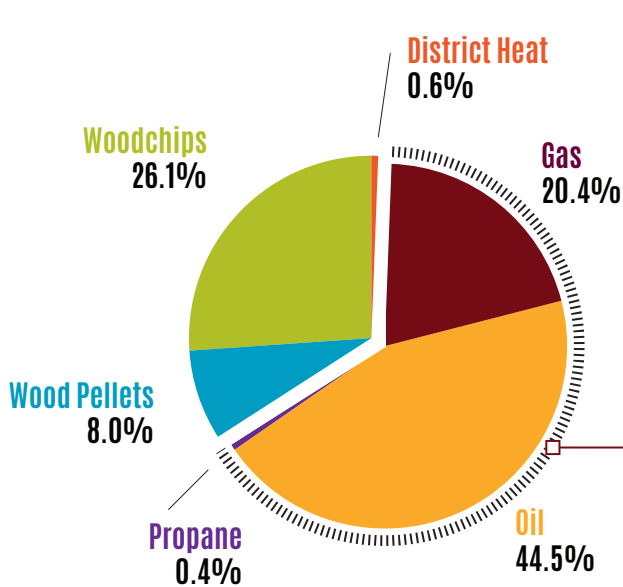

FIGURE 1: Percentage of Vermont school square footage heated by each fuel type

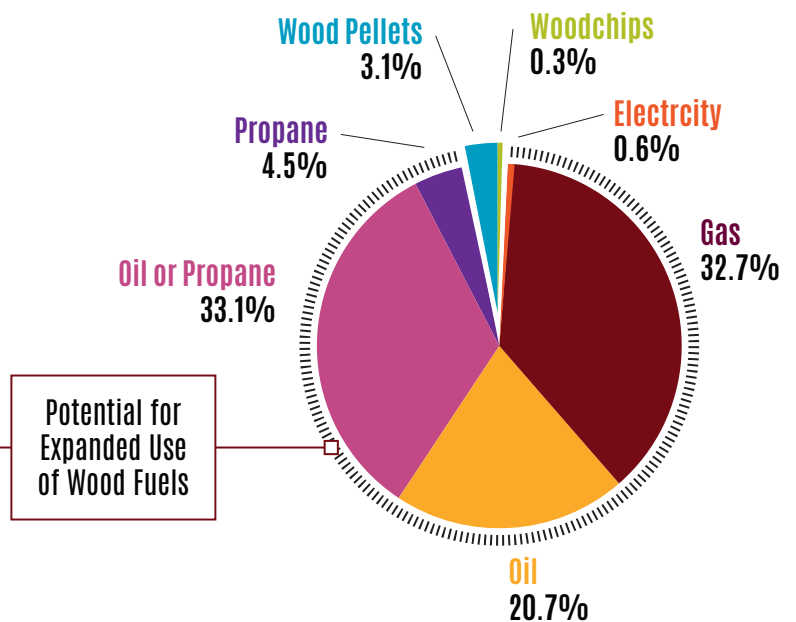

FIGURE 2: Percentage of Vermont multifamily housing square footage heated by each fuel type

	PRIMARY FUEL							GRAND TOTAL
	ELECTRICITY	GAS	OIL	OIL OR PROPANE	PROPANE	WOOD PELLETS	WOODCHIPS	
Number of properties (2015)	4	152	134	217	28	29	1	289
Total number of units	81	5,426	2,734	4,691	645	772	49	14,398
Average units per property	20	36	20	22	23	28	49	26
Average building size (sq. ft.)	20,065	35,207	20,436	21,501	22,217	27,283	48,553	25,309
Average potential fuel savings when switching to wood (per property)	\$12,367	\$5,617	\$3,667	\$4,528	\$8,027	n/a	n/a	\$4,641
Total annual savings if all properties switched to wood	\$49,468	\$168,503	\$491,432	\$978,123	\$224,765	n/a	n/a	\$1,912,292
Total gallons of oil or propane replaced if all properties switched to wood	n/a	n/a	847,955	1,438,098	291,900	n/a	n/a	2,577,953

TABLE 1: Summary of Primary Fuel Use and Potential Savings at Vermont’s Multi-family Affordable Housing¹

Historically, wood heating fuels have been much cheaper than fossil fuels used for heat. If all multi-family affordable housing facilities switched to wood heat, the combustion of 2.6 million gallons of oil and propane would be avoided each year, and millions of dollars would be saved each year² on fuel costs (Table 1).

1 1.9 million dollars would be saved, assuming fuel price of \$2.20 per gallon for propane, and \$2.76 per gallon for oil, \$57 per ton for woodchips, \$260 per ton for wood pellets (Source: VT Fuel For Schools and DPS historical data); Savings assuming fuel price of \$2.20 per gallon for propane, and \$2.76 per gallon for oil, \$57 per ton for woodchips, \$260 per ton for wood pellets (Source: VT Fuel For Schools and DPS historical data)

2 Savings assuming fuel price of \$2.20 per gallon for propane, and \$2.76 per gallon for oil, \$57 per ton for woodchips, \$260 per ton for wood pellets (Source: VT Fuel For Schools and DPS historical data)



2 Comparing Heating Fuel Costs

This chapter provides information necessary to make an accurate comparison of the costs of various heating fuels commonly used in Vermont.

It can be very difficult to predict future heating costs due to the volatility of fossil fuel pricing from year to year. Comparing the cost of heating fuels can also be confusing because different fuels are measured in different units (gallons, cubic feet, tons, cords, etc.) and have different energy values. Adding to the confusion, some fuels, like wood, contain moisture that further skews the real energy content.

Using cost per million British thermal unit (Btu), after combustion, (Table 2) allows us to better understand the true costs of a given heating fuel and to compare different heating fuels on an “apples to apples” basis while factoring in the diverse combustion efficiencies realized with different fuel types.

If you would like to compare two heating fuels, select the per-unit price closest to what you are paying in Table 2 below³. Look down to find the equivalent in “delivered heat cost \$/million Btu” in the highlighted row. Then select the fuel you are comparing this to and find its cost per unit equivalent. For example, if someone is paying \$2.20 per gallon for heating oil **fuel**, they are actually paying \$20 per million Btu for delivered **heat**. If someone pays \$270 per ton for pellets as their heating **fuel**, they are also paying around \$20 per million Btu for delivered **heat**.

DELIVERED FUEL COST	Oil \$/gallon			\$1.70	\$2.20	\$2.75	\$3.30	\$3.90	\$4.40	\$5.50		
	Propane \$/gallon			\$1.10	\$1.50	\$1.80	\$2.20	\$2.60	\$2.90	\$3.30	\$3.70	
	Wood Pellets \$/ton			\$200	\$270	\$330						
	Woodchips \$/ton	\$30	\$58	\$90								
DELIVERED HEAT COST (\$/MILLION Btu)	\$5	\$10	\$15	\$20	\$25	\$30	\$35	\$40	\$45	\$50	\$55	

TABLE 2: Comparison of heating fuel cost ranges on a per unit of heat delivered basis

³ Assumptions: 16.4 MMBtu/ ton of pellet, 8.6 MMBtu/ green ton of woodchips; efficiency of pellet boiler is 80%, efficiency of woodchip boiler is 67%, all other assumptions as in the DPS monthly fuel report.

3 Wood Heating Fuels

Facility managers considering wood heat often wonder about the different types of wood fuels available and how they compare. This section provides a short overview of the most commonly used wood heating fuels and their origin.

Vermont is approximately 75% forested and each year Vermont's forests are estimated to grow roughly twice as much new wood as is currently harvested.

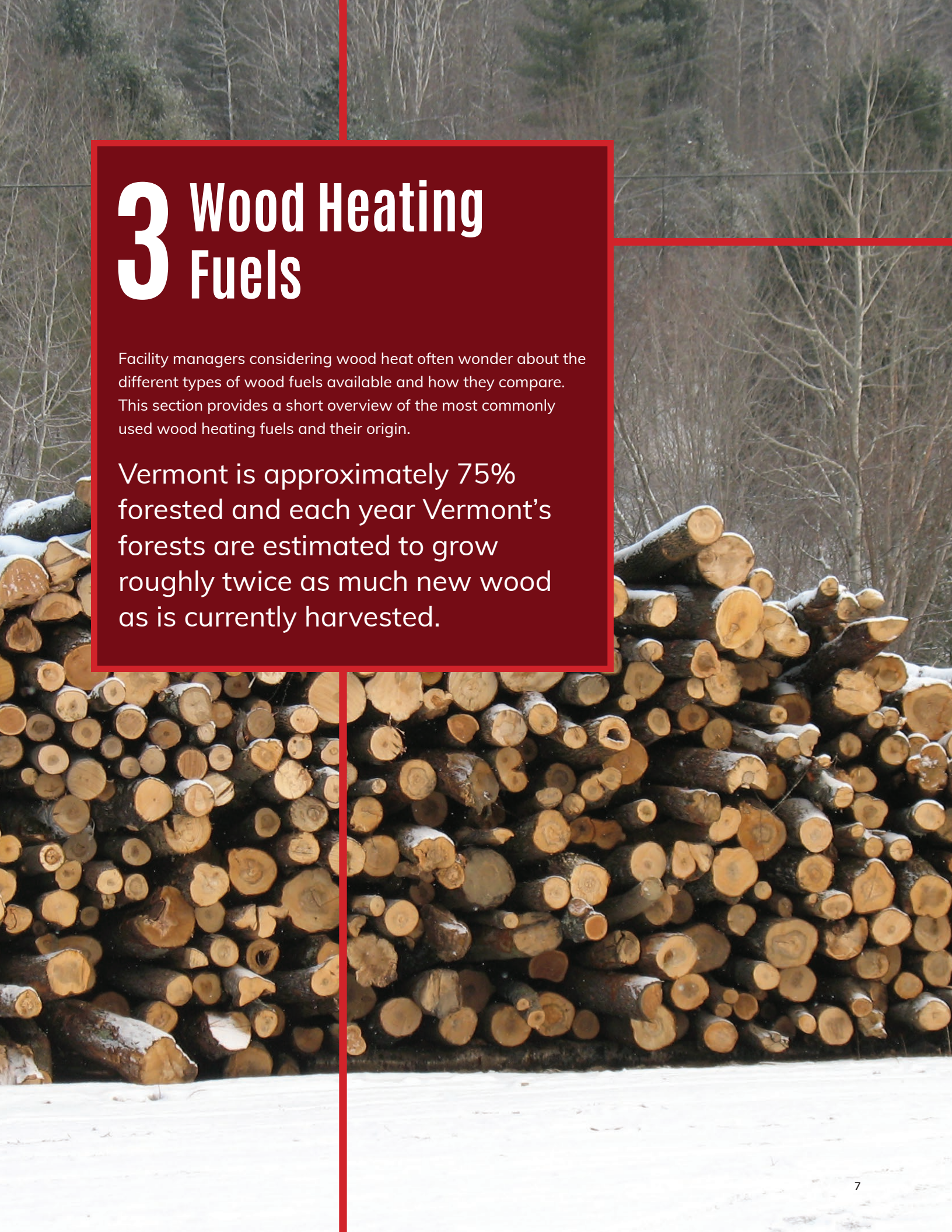

With recent changes in traditional forest product markets and a dramatic regional decline in demand for wood used in paper making, new local markets for low-grade wood are needed to help sustain Vermont's forested "working landscape". Thinning out low-quality trees to help invigorate the growth and health of higher-quality trees is a cornerstone of good forest management. Heating with local woodchips, pellets, and cordwood helps create local markets for that low-quality wood!

VERMONT FOREST RESOURCE STATISTICS

4.5
million
acres

80%
private
ownership

NEARLY 50%
of private land enrolled in
CURRENT USE PROGRAM

About Use Value Appraisal (Current Use): fpr.vermont.gov/forest/your_woods/use_value_appraisal

Wood Pellet Fuel



Wood pellets are small granules made of compressed wood fibers and make excellent fuel. Wood pellets are a refined heating fuel engineered to have high energy density and low ash and moisture content. Pellets are typically made from by-products like sawdust and woodchips from the wood manufacturing industry but may also be made from low-grade wood sourced from local timber harvesting operations.

Pellets are widely available in Vermont and are a cost-effective heating fuel with several distinct advantages over other fuel types.

Wood pellets are:

- » **Dry** – making them efficient and easy to burn.
- » **Energy dense** – making them cost-effective to transport and store.
- » **Consistent shape and size** – making them easy to move through the boiler's feeding systems.

Wood pellets are entirely made of wood – there are no additives or binders. When wood fibers are extruded under pressure, the heat generated melts the natural lignin in the wood fiber, forming hard, durable pellets.

Wood pellets are of uniform size and shape (between 1-1½ inches by approximately 1/4-5/16 inches in diameter), making them as easy to store and use as traditional fossil fuels used for heating. Compared to other wood fuels, wood pellets take up much less space in storage because they have a higher energy content by weight (roughly 7,750 Btu per pound at six percent moisture content) due to densification and drying. The Pellet Fuels Institute (PFI) has created a standard differentiating three pellet grades, based on the parameters featured in Table 3 below⁴. The proportion of softwood or hardwood species included in pellets is not part of the PFI standard and pellets may include varying proportions of each. It is important to note that there are subtle differences between hardwood and softwood pellets, but these minor differences are more relevant for a residential stove.

	PREMIUM	STANDARD	UTILITY
Bulk Density (lbs/ft ²)	40.0 - 48.0	38.0 - 48.0	38.0 - 48.0
Durability Index	>96.5	>95.0	>95.0
Fines (% at mill gate)	<0.50	<1.0	<1.0
Inorganic Ash Content (%)	<1.0	<2.0	<6.0
Moisture	<8.0	<10.0	<10.0
Chloride (PPM)	<300	<300	<300

TABLE 3: Characteristics of Different Grades of Wood Pellets as defined by the Pellet Fuels Institute

Premium and standard grade pellets are suitable for any wood pellet boiler with automatic ash removal, including most institutional or commercial-scale applications. Industrial- or utility- grade pellets with ash content over 3.0% may require specialized equipment and system engineering to ensure optimal performance with this fuel.

⁴ Pellet Fuel Institute (PFI) Standard, www.pelletheat.org

In 2017, Vermont has one pellet mill and there are plans for a second. Additionally, there are dozens of pellet mills in the Northeast region (Figure 3)⁵.

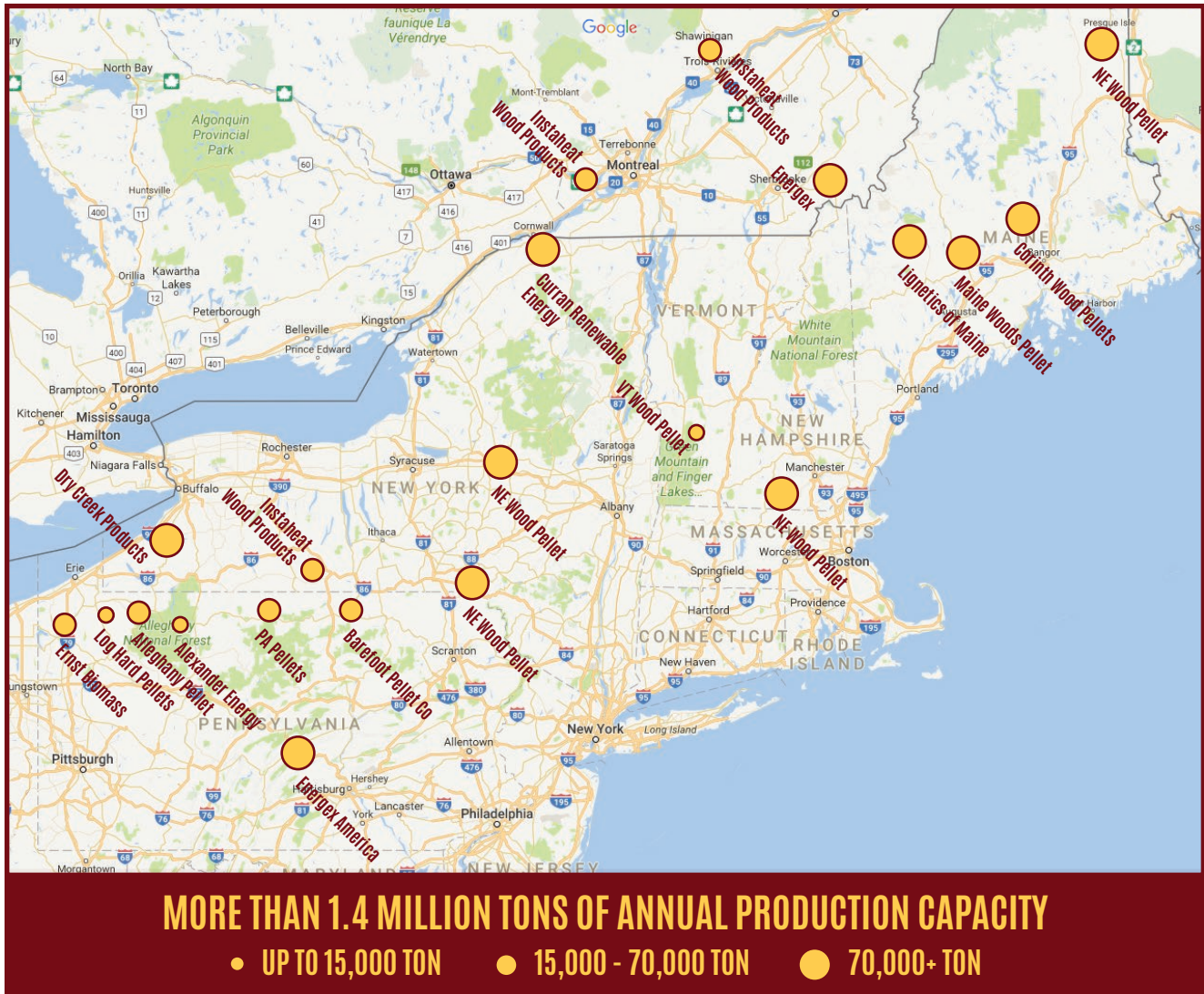

FIGURE 3: Locations of pellet mills in the Northeastern US and Quebec.

Most pellet mills in the region sell pellets in 40-pound bags and in loose bulk form. Numerous companies in the region own and operate specialized bulk pellet delivery trucks that can deliver bulk pellets to customers by the ton. These trucks range in payload size from 8 to 25 tons of capacity and use pneumatic systems to gently off-load the pellets from the truck into on-site fuel storage bins. A list of service providers that deliver bulk pellet fuel can be found in [Chapter 9 – Resources Available to Affordable Housing Providers](#).

⁵ Data Source: Pellet Mill Magazine

Woodchip Fuel



Woodchips are a simple, cost effective automated wood fuel which is commonly available in Vermont. Cost per delivered million Btu is typically lower than pellets, but capital cost of installations is often higher making them a better choice for larger facilities. Woodchip heating systems will function and perform better with a high quality fuel. Using consistent, uniform sized woodchips results in fewer mechanical jams of the fuel feeding equipment. Feeding lower moisture content woodchips to the system typically requires less fuel to produce the same amount of heat. Cleaner woodchips (free of excess bark, needle, dirt, and debris) produce less ash and can burn longer without maintenance and removal of ash. Not all woodchip heating systems will require the same quality of fuel, so matching the right fuel source and quality to the right system and application is extremely important. If possible, larger woodchip systems should be designed for a range of fuel quality. Larger woodchip systems can be equipped with fuel feeding systems designed to remove oversized materials.

Quality woodchips are consistent in shape and size. Typical high-quality chips vary in size from 1" x 1" x 1/8" thick to 2 1/4" x 2 1/4" x 1/4" thick. Conveying and feeding chips that are relatively square and flat into the system is easier and goes more smoothly. While the majority of woodchip heating systems can handle some oversized material, long "stringers" (i.e. small branches and long fibers) can present a risk for jamming feed augers and shutting the system down. Long stringy wood can also often "bridge" in hoppers and bins, meaning it can form hollow cavities as the material below is removed. Material bridging can cause some systems to shut down due to the perception that the bin is out of fuel when it is not.

Similarly, while most woodchip heating systems are designed to handle some amount of wood "fines" (i.e. sawdust), a high fines content can present issues when moisture content is either too low or too high.

Grades of Woodchips

Woodchips used for heating fuel can be made from many different tree species, components of trees, and can be produced by a variety of harvesting methods. Table 4⁶ below presents the typical quality characteristic of several different grades of woodchips commonly used as heating fuel.

	SAWMILL	SCREENED BOLE	STANDARD BOLE	WHOLE-TREE
Target chip dimensions	1.5" x 1.5" x 0.25"	2"x 2" x 0.25"	2"x 2" x 0.25"	2" x 2" x 0.25"
Target percent over sized	1%	3%	5%	8%
Target percent fines	2%	4%	5%	8%
Target moisture content	35-42%	38-45%	38-45%	38-45%
Target ash content	0.5%	1.0%	1.5%	2.0%
Target "as is" energy value (Btu/lb)	5,160	4,988	4,902	4,816

TABLE 4⁶: Characteristics of Different Woodchip Grades

Sawmill Grade Woodchips

Historically, **sawmill grade woodchips** have been supplied to wood heat users by sawmills looking to sell their by-product chips. However, sawmill activity in the Northeast has declined in recent years and as a result, by-product material is increasingly limited in supply. Today, many woodchip-heated facilities source their fuel either directly from local timber harvesting and chipping contractors or via woodchip brokers.

Bole Chips

"Bole" chips are the most commonly used type of heating fuel woodchips and are produced by chipping just the stem (or bole) of low-quality hardwood trees. They can be produced in the woods, but are most commonly produced at chip yards where roundwood is stored until it is chipped and delivered in tractor trailer loads to the various local heating plants as needed. Chip yards aggregate and store harvested roundwood throughout the year. The wood in these piles may come from a number of harvest jobs and suppliers, each with different forest management goals.



⁶ Woodchip Heating Fuel specification in the Northeastern United States, BEREC, 2011, http://www.biomasscenter.org/images/stories/Woodchip_Heating_Fuel_Specs_electronic.pdf

Screened Bole Chips

Since bole chips are less regular in size and shape than chips produced as by-product in sawmills, some suppliers have invested in screening equipment to further refine their product by removing oversize chips, branches, dirt, debris and sawdust. These are typically referred to as “screened bole chips”.

Whole-Tree Chips

Conventional harvesting systems remove the main stem (or bole) of the tree and leave the severed tree tops and branches scattered in the woods. By contrast, whole-tree harvesting removes the main stem with the top attached to a central landing where the wood is processed and sorted. In many harvest operations, loggers return a portion of these tops and limbs to the forest and use them on skid trails to reduce rutting and soil compaction. The remaining top wood can be chipped into a wood fuel commonly known as whole-tree chips. It is common practice for that wood to be chipped at the log landing into box trailers, which are transported directly to large users such as power plants.

Custom Dried Chips

Dried woodchips have recently become available from some suppliers and provide several benefits: increase of fuel quality and energy value of the chips, increased combustion efficiency, reduced emissions, reduced fuel storage requirements, reduced transport costs, and reduction of a visible steam plume from the stack.

Additional Characteristics

Not all boilers can be tuned to burn either green or dry woodchips and may require modifications. Some boilers are designed specifically for dry woodchips, and some are designed to burn both dry woodchips and pellets. System vendors should be consulted to confirm the boiler’s ability to burn dry woodchips prior to selecting a system.

Drying of woodchips can be done either passively by relying on ambient temperature and air flow, or actively through the use of fans. Heating the air surrounding the woodchips can speed up the drying process. Drying woodchips typically brings moisture content down to under 30% in a few days with warmed air. Drying chips to less than 25% moisture requires a heat and energy input that usually exceeds the benefits of drying woodchips.

The mineral (or ash) content of the fuel is a very important factor in the overall chip quality for several reasons. Minerals bound in wood contribute to the formation of ash once the rest of the wood is combusted. In general, the lower the mineral or ash content, the better. Ideally, the ash

content of chips for heating should be below 1.5 percent. Ash can come from two main sources: the naturally occurring minerals contained in the tree and bark, and the dirt and debris picked up from the soil in the process of harvesting and other poor materials handling practices.

Energy values for woodchips can also vary widely—from a higher heating value (HHV)⁷ of 8,000 to 10,200 British thermal units⁸ (Btu) per dry pound. Woodchip fuel users will likely be buying woodchips on a green weight basis and not a volume basis. Woodchip species composition is only important because moisture content can vary by species. The species of tree that the wood came from also affects the amount of energy present in a given volume of woodchips, because the density of wood varies by species, but the density of wood is only important when buying wood by volume, such as for cordwood, and not for woodchips. From when a tree is cut to when it is eventually burned, moisture content typically decreases due to some air drying. During combustion, the remaining moisture content of wood fuel vaporizes and absorbs energy in the process. In general, this moisture escapes out the stack as heated water vapor.

If the moisture content is too high, green woodchips will be difficult to handle, risk freezing in winter, and have lower fuel value resulting in the need to burn significantly more fuel to extract the same amount of energy as from a drier fuel. If the fuel is too dry there can be problems from dust. The optimal moisture content for green woodchips is 30-40%, but most woodchip combustion systems can handle wood fuel that ranges from 15-50%. In Vermont, the average moisture content of woodchips used as heating fuel is 42%⁹. Consistency in moisture content is almost as important as the fuel being within the acceptable moisture content range.

Woodchips are readily available as a heating fuel in Vermont primarily through sawmills, trucking companies and woodchip contractors who chip low-grade hardwood logs at aggregation/processing yards around the State. Forty-eight foot, live-bottom trailers¹⁰ (Self-unloading trailer with a mechanism to push the chips out) typically deliver 22-28 tons of woodchips per load. Before executing supply contracts, be sure to contact state officials to determine if any restrictions may apply on wood fuel imports due to pest and disease quarantines.

A list of woodchip suppliers can be found in [Chapter 9 – Resources Available to Affordable Housing Providers](#).



Courtesy DH Hardwick and Sons

⁷ Higher heating value (HHV) measures the energy content of perfectly dry wood (zero percent moisture content). Energy content can also be expressed as the lower heating value (LHV) or the net energy content after accounting for the wood's moisture content and further energy losses due to vaporization of water during combustion. LHV is determined by subtracting the heat of vaporization of the water vapor from the HHV.

⁸ British thermal unit (Btu) is a unit of heat equal to the amount of heat required to raise one pound of water one degree Fahrenheit.

⁹ Based on periodic laboratory analysis of green woodchip fuel sampled from Vermont woodchip heated facilities over the past decade.

¹⁰ Self-unloading trailer with a mechanism to push the chips out

Cordwood Fuel



Cordwood is produced from the trunk or top wood of a tree that has been cut and split, and then dried. Cordwood boilers are designed to handle wood that has been dried to less than 20% moisture content. Cordwood can be stored on site and does not require the construction of a dedicated storage structure, but to maintain its low moisture content, it needs to be stored protected from the elements.

When dry, clean cordwood is burned in a well-tuned, modern cordwood boiler, it can be a very good option for heating with a source of locally available wood that undergoes minimal processing.

The energy content of cordwood (by volume) will depend on the tree species that the wood came from, any decomposition of the wood fiber that already occurred as a result of improper storage and moisture content of the wood at the time of combustion.

While tree species affects the amount of energy content of wood in a set volume of cordwood (because tree density varies by species), in reality, when purchasing cordwood, the buyer typically purchases a mix of species that is representative of the mix of low-grade trees that was cut on a particular forest stand.

Cordwood heat content greatly depends on the amount of moisture present in the wood. Drier cordwood contains more energy by volume than cordwood with a higher moisture content ("green"). Green cordwood may contain 50% or more of water by weight. Cordwood can be air-dried ("seasoned"), or dried in kilns to bring the moisture content down.

Cordwood is typically sold by volume, a standard cord or full cord measures 4 feet tall by 8 feet long, by 4 feet deep. Local dealers are located throughout Vermont and delivery distances from the woodlot or processing yard to the facility can often be kept short, as long as a local supply is available.

Cordwood can be purchased green and dried on-site, or it can be purchased air or kiln-dried. Boilers can burn most efficiently when the wood supply is uniform in moisture content. Kiln-dried firewood is typically more uniform in moisture content than wood dried in a woodshed, where drying will be affected by where a piece of wood is located in the stack. Kiln-dried wood has a relatively uniform moisture content, usually around 20-25%. Kiln-dried firewood usually costs more by volume than seasoned or green wood, and delivery distances may be greater depending on the location of the supplier.

Cordwood should be used locally and not transported over long distances to avoid transporting pest species to areas where they are not present yet. Many states, including Vermont, have quarantines in place that limit the movement of wood into the state from out of state sources. Heat treating cordwood to a standard set in state or Federal rules can destroy insect pests. Heat treating cordwood certified by state or Federal agencies limits the spread of insect pest and is specified in quarantine areas. It is important to note that heat treated wood may not be kiln dried and kiln-dried wood may not be heat treated.

Dry firewood typically costs more by volume than green firewood, but it can be burned right away without requiring lengthy on-site storage for drying. If only green cordwood is purchased, the storage and drying area will have to be sized large enough to store at least one full heating season worth of cordwood.

Pros and Cons of Each Fuel

	+ PRO	- CON
BULK DELIVERED WOOD PELLETS	<ul style="list-style-type: none"> » Dry – making them efficient and easy to burn. » Energy dense – making them cost-effective to transport and store. » Consistent shape and size – making them easy to move through the boiler’s feeding systems. 	<ul style="list-style-type: none"> » Higher fuel cost relative to woodchips or cordwood. » Trucking distances from nearest mill can be greater depending on location. » Pellets should stay dry and be handled properly to avoid pellet breakage and creation of dust.
WOODCHIPS	<ul style="list-style-type: none"> » Simple, effective low-cost automated fuel. » Require low energy and carbon inputs. » Widely available from multiple sources. 	<ul style="list-style-type: none"> » Contains moisture, leading to lower delivered energy content by volume of fuel stored compared to pellets. » Woodchip quality and heating system equipment must be properly matched to allow for efficient combustion and to avoid fuel conveyance issues. » Generally only available in large delivery volumes.
CORDWOOD	<ul style="list-style-type: none"> » Simple, low cost, and locally available fuel. 	<ul style="list-style-type: none"> » Much more variable in terms of size and volume, heat content, and moisture content than other options. » Requires manual loading and therefore high labor requirements.

4 Modern Wood Heat Technology

This chapter provides an overview of the components and modern technologies available to heat facilities with wood.

Modern wood heating utilizes proven technology that has been used successfully for decades in Vermont to provide space heating and domestic hot water in a wide range of settings – from schools and multifamily housing apartment buildings to colleges and office buildings.

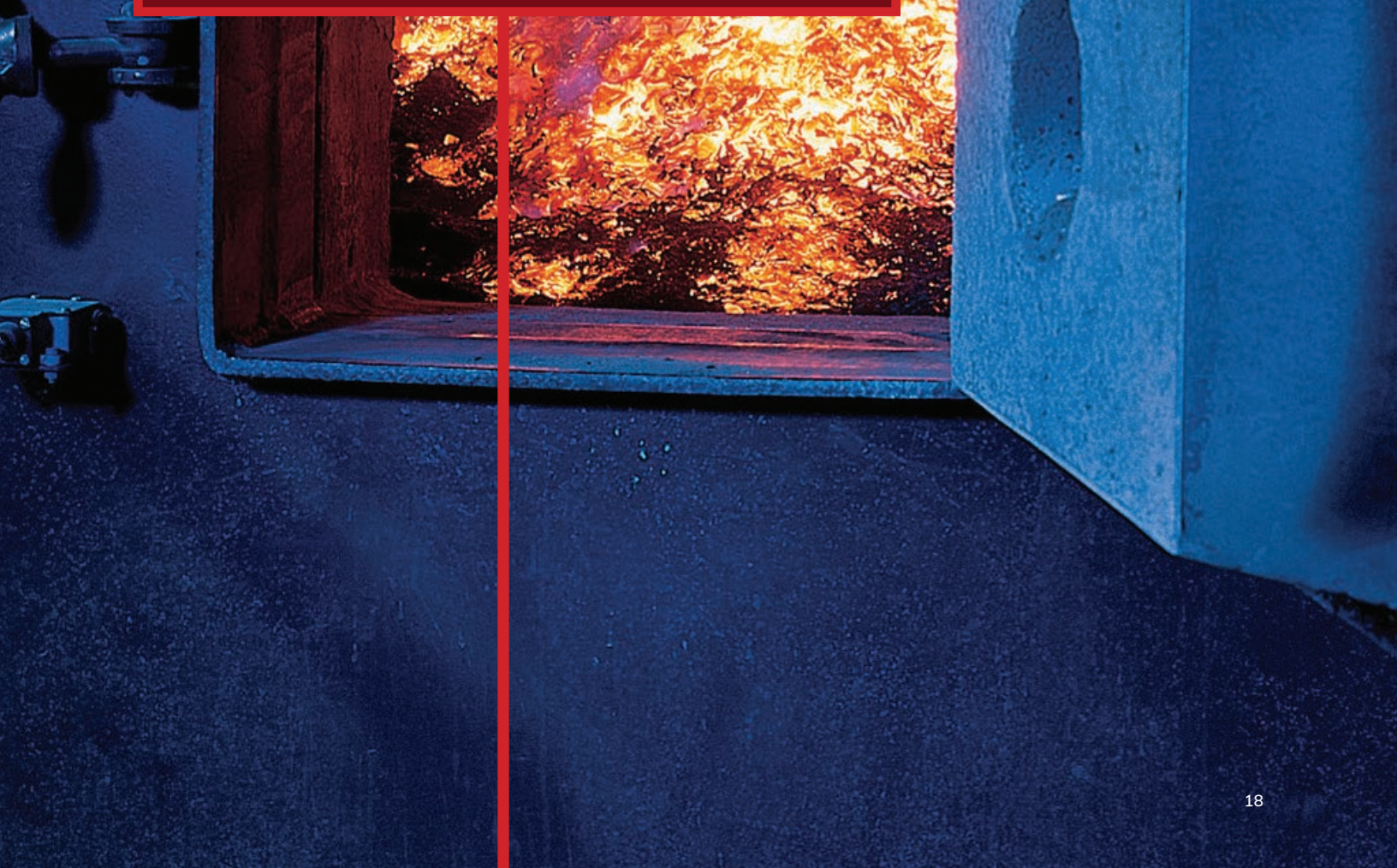

While stoves and furnaces that produce hot air are good options for homes and small commercial buildings, this guidebook is focused on modern boiler systems and designs that utilize high efficiency, clean burning/low emitting wood energy equipment and mechanical designs that produce hot water that can be circulated via a hot water (“hydronic”) heat distribution system. It should be noted, however, that wood-fueled boilers can be relatively easily retrofitted to convert hot water to warm air and used in buildings internally equipped with ducts to circulate warm air.

Three modern wood heating options are currently commercially available and suitable for multifamily buildings with a hydronic heat distribution system looking to switch to wood heat:

1) Wood pellet systems 2) Woodchip systems 3) Cordwood systems

While some multifamily buildings have installed cordwood boilers, this option is much less prevalent and is therefore discussed in less detail in this guide. Modern wood heating systems typically include the following key components:

COMPONENT	DESCRIPTION
Boiler room/plant	A room or dedicated building housing all the equipment and the fuel storage area.
Fuel Receiving and Storage Area	Area where the wood fuel is unloaded and stored to keep fuel clean and dry, often configured as: <ul style="list-style-type: none"> » a rectangular, below-grade concrete bin » a rectangular three-sided bunker on a flat slab » Vertical silos » Or various other creative solutions
Fuel-handling Equipment	Belt conveyors and augers used to move the wood fuel from the storage area to the boiler and inject controlled amounts of fuel into the primary combustion chamber.
Combustor/ Heat exchanger (Boiler)	Equipment where the fuel is combusted and hot water is heated for building heat and domestic hot water needs.
Chimney and Emission Controls	Conduit through which combustion gases are exhausted. Some larger systems also have additional flue-gas cleaning equipment to further control particulate emissions.
System Controls	Computer software, sensors, and fans that ensure efficient, clean combustion of the wood fuel.
Ash Collection	Receptacle allowing for the collection and disposal of ash resulting from combustion.
Thermal storage	A highly insulated water tank located between the boiler and the hydronic heat distribution system that can improve system performance.
Safety Devices	Code-mandated safety devices and controls associated with any large heating system, as well as safeguards against burn-back, or fire traveling back from the combustion area along the incoming fuel stream

More details on these key components are presented for all three wood fuel types in the following sections. A comprehensive discussion of these technologies can be also found in guidebooks listed in [Chapter 9 – Resources Available to Affordable Housing Providers](#).

System Configurations

One of the important site characteristics that needs to be taken into account when considering a wood heating system is the facility's site layout. There should be adequate space for the wood heating system and fuel storage area, as well as adequate access to the storage area for fuel truck deliveries. Three main options for integrating a wood heating system are:

- 1) Install the wood system and its associated components into an existing space,
- 2) Construct a new heating plant to house the wood heating system and components (Figure 4), or
- 3) Install an integrated containerized solution (see Figure 5).



Courtesy Sally MacCay

FIGURE 4: Example of a small, simple dedicated heating plant



Courtesy hwenergy

FIGURE 5: Installation of a containerized system

CONTAINERIZED SOLUTIONS



Courtesy / hvenergy

Some suppliers now offer containerized systems where the boiler(s), wood fuel storage, wood fuel handling and all associated components of the plant are contained in a single, pre-fabricated unit. Systems of this kind up to 1.5 million Btu/hr in size have been installed in the region (with larger systems possible using modular capacity).

They are, essentially 'plug and play' options that offer several advantages such as: minimizing disruption to existing buildings, speed of installations, and simplicity. In the right circumstances, they can be very cost-effective solutions.

Wood Pellet Systems

Wood pellet boilers are relatively simple systems that are easily installed and operated. A pellet boiler is usually delivered completely assembled; however, some pieces, like the fuel hopper, may be disassembled prior to installation to facilitate installation of the boiler in a tight space.

When a wood pellet boiler is purchased, the vendor will typically supply not only the pellet boiler, but also the fuel handling equipment, chimney connection and automated controls. The vendor may also supply the pellet storage silo, and install thermal storage, or another contractor may install these and integrate them with the controls.

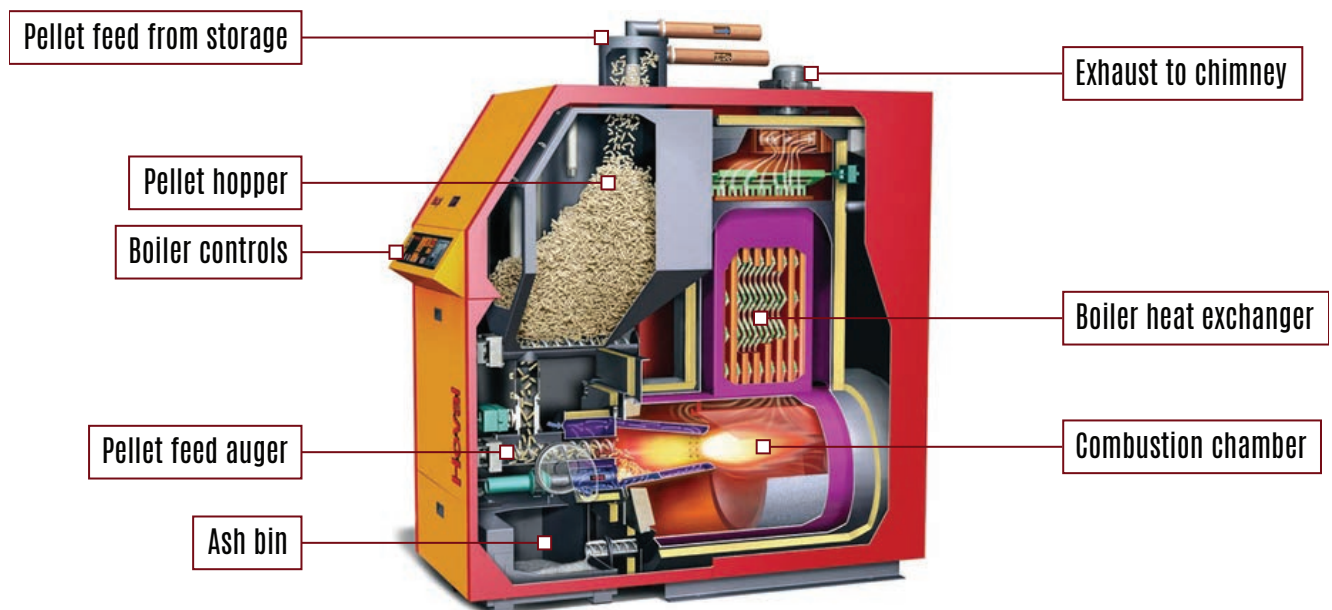

FIGURE 6: Wood Pellet Boiler Key Components

Fuel Receiving and Storage Area

Trucks similar to those that deliver grain typically deliver bulk wood pellet fuel for the institutional- or commercial-scale market. Pellet fuel can be stored in the same type of standard outdoor silo used to hold grain or animal feed, or in silos specifically made for fuel pellets. Pellets can also be stored indoors in fabric bags or dedicated rooms.

A good rule for sizing fuel storage capacity is to choose one that is somewhat larger (e.g. 1.5 times) than the capacity of the fuel delivery truck used by the supplier. Since there will always be some pellets remaining in storage at the time of next delivery, this sizing will maximize delivery efficiency, particularly since delivery charges for wood pellets are often by the load rather than by the actual quantity. If the supplier uses a 10-ton delivery truck, the storage capacity should be 15 tons or more. Storage capacity should be sized in increments of 10, 15, 25, or 35 tons. For small commercial- or institutional-scale boiler systems, storage capacity should be at least 15 tons.



Courtesy, Vermont Renewable Fuels Inc



Outdoor Silo



Indoor Fabric Bag

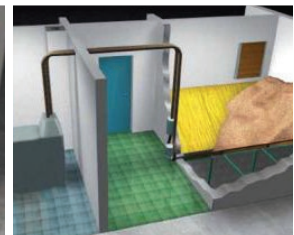

Indoor Dedicated Room

Fuel Handling Equipment

Auger systems similar to those used for conveying feed and grain on farms automatically feed wood pellet fuel to the boiler. The pellets are discharged from the silo and conveyed to the day hopper (temporary holding area next to the boiler) or directly to the boiler using automatically controlled augers or a vacuum. The augers or vacuum are set to provide the right amount of fuel based on the building's demand for heat. The wood pellets are fed from the fuel hopper through the fuel feed system into the combustion chamber at a rate determined by the control settings.

Wood Pellet Boiler

COMBUSTION CHAMBER

The combustion chamber is where the pellets are burned to produce heat. It is accessible for cleaning or maintenance through the fire door. Combustion fans provide air to the fire in the combustion chamber.

CHIMNEY

The exhaust is ducted to the chimney through a port at the rear of the system, which connects to either a new or an existing chimney.

SYSTEM CONTROLS

The control unit allows the user to control the flow of wood pellets and combustion air into the boiler based on temperature settings. The unit also gives readings on boiler and exhaust temperatures. In addition to combustion controls, system controls integrate other components, such as backup boilers and thermal storage, with the pellet boiler.

ASH COLLECTION

Ash must periodically be removed and can be accessed through an ash pan door.

Thermal Storage

Thermal storage can provide many benefits when properly designed, installed and controlled in conjunction with wood-fired hydronic heating systems. The idea behind thermal storage is to reduce the time spent in low-fire operations and on/off cycles, thus providing greater efficiency and responsiveness to load.

For a discussion of this component, see [Chapter 5 – Modern Wood Heat System Design Considerations, Thermal Storage](#).

Woodchip Systems

Typically, equipment provided and installed by a woodchip boiler vendor includes:

- » Storage area with access to unload the woodchips from a delivery truck,
- » Fuel handling equipment that carries woodchip fuel from the storage bin to the boiler (conveyors and augers, and metering bins),
- » Combustion chamber and boiler,
- » Combustion air supply fans,
- » Boiler connection to the stack,
- » System electronic controls,
- » Safety devices (back-burn fire suppression), and
- » Emissions control equipment (usually).

Various manufacturers of biomass boilers offer different fuel feeding, fuel combustion configuration, thermal storage, and ash removal features. A more detailed discussion of woodchip boiler components can be found in *Woodchip Heating Systems, A Guide for Institutional and Commercial Biomass Installations*:

www.biomasscenter.org/pdfs/Wood-Chip-Heating-Guide.pdf.

Fuel Receiving and Storage Area, and Fuel Handling Equipment

Typically woodchip fuel storage is co-located with the central boiler house. The amount of fuel required to be stored will determine the size of the storage area. The exact location of the woodchip receiving and storage area should be chosen to help facilitate easy truck access.

As with pellet boilers, woodchip systems can be designed to be either fully automated with conveyors, augers and/or moving floors moving the woodchips from storage to the burner, or semi-automated, with an operator using a small bucket loader to move chips from a long-term storage area to a day bin that feeds it to the burner.



FIGURE 7: Woodchip fuel moving from storage to burner on a conveyor

Fully-automated systems generally require limited operator attention – typically about one half hour daily during the heating season. They are a good match for buildings where the maintenance staff has a large workload and does not have much time to devote to the heating plant. These systems are well suited to buildings with significant heat loads and high fossil fuel costs. This high level of operator convenience usually requires costly equipment and a costly building. Fully-automated systems (Figure 8) typically employ a below-grade chip storage bin or, if the situation requires, vertical storage silos equipped with a heating loop to keep woodchips from freezing can be used.

Courtesy Schmidt Energy Solutions

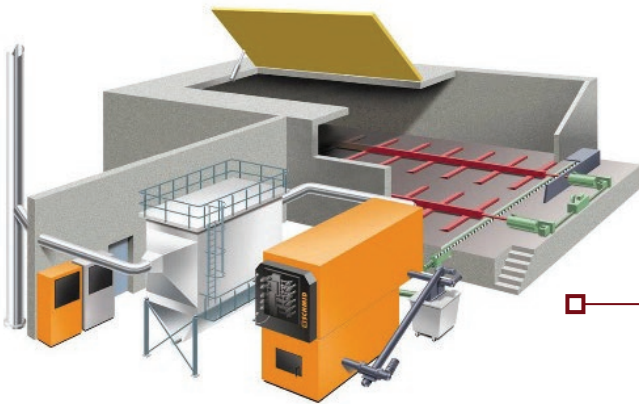
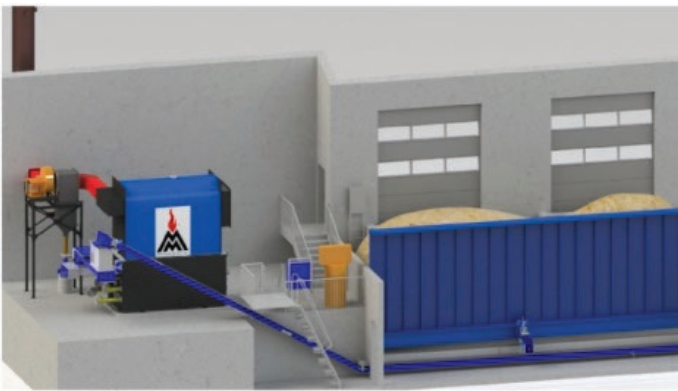

FIGURE 8: Examples of Configurations of Fully Automated Woodchip Boiler and Storage Area

- » Below-grade storage bin equipped with moving floor and augers to move woodchips to boiler
- » Woodchips unloaded from delivery truck through trap door
- » Typically used for green chips

Courtesy Messersmith Manufacturing, Inc.



- » Below-grade bins accessed via garage bays for fuel deliveries
- » Bins use traveling auger to feed conveyor to boiler
- » Typically used for green chips

Courtesy Schmidt Energy Solutions

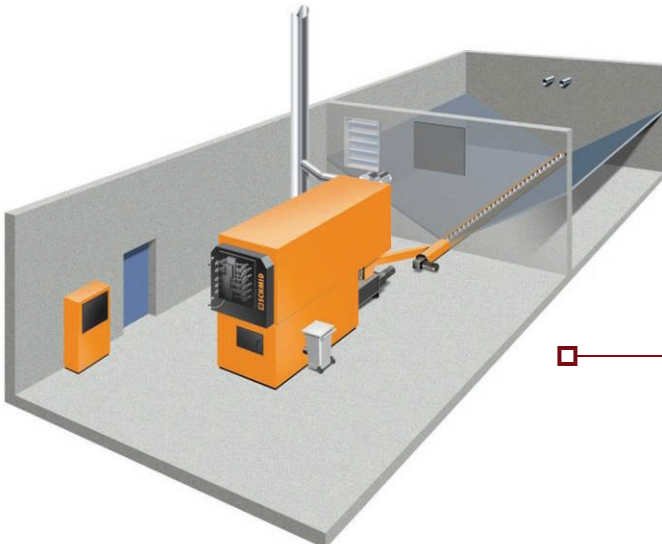

- » On-grade V-bottom storage bin equipped with auger connected to boiler
- » Requires blower truck for fuel delivery
- » For dry chip storage only

Semi-automated wood systems use less expensive slab-on-grade fuel storage: the woodchips sit in a big pile on the slab. Where conditions dictate, a separate woodchip receiving and roofed storage area can also be used. Woodchip deliveries are then received in the main yard and chips could then be pushed up into a simple pole barn woodchip storage shed to keep chips dry. Once or twice a day the operator uses a small tractor or skid steer to move the chips to a small day bin that in turn feeds the boiler automatically. Operator time to fill the day bin is as much as one hour daily. The day bin could be placed inside the building if that is the preference of the owner and/or design team. The day bin is generally sized to store 24 hours of woodchips, if the system were operating continuously at peak load conditions. From the chip day bin, the fuel is fed automatically to the boiler. No operator assistance is required for fuel handling from the day bin to the boiler. Semi-automated systems are less costly initially but require more labor, and moving equipment such as bucket-loaders. Semi-automated systems are simpler and have fewer advanced features than fully automated systems.

Woodchip Boiler

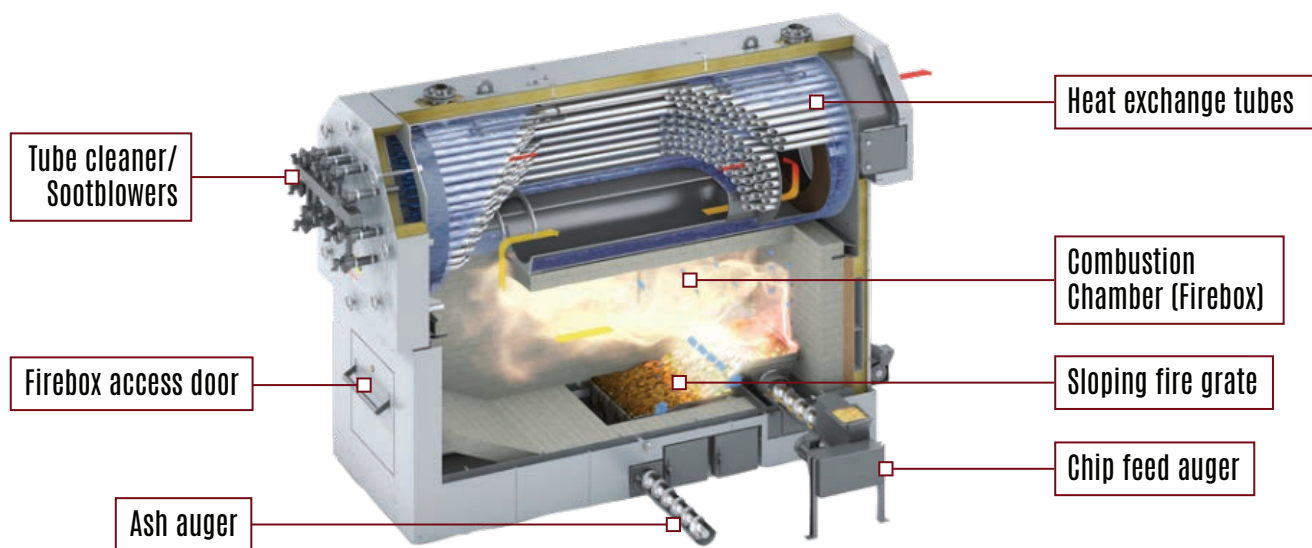

FIGURE 9: Woodchip Boiler Key Components

COMBUSTION CHAMBER

The combustion chamber is the part of the combustion appliance where burning of the solid fuel actually takes place. Fuel is automatically injected into the combustion chamber, combustion air is added, and the fuel burns to produce heat. The hot exhaust gases then flow out of the furnace area and into the heat exchanger. As they pass through the heat exchanger, heat is transferred to the surrounding water. The cooled exhaust gases then pass up the chimney for discharge into the outdoor air.

CHIMNEY AND EMISSION CONTROL

The chimney or stack's job is to remove the products of combustion from the combustion system and the building, and to disperse the flue gases to the atmosphere. Adequate dispersal of stack gases is extremely important when the wood heating plant is located in a heavily populated area or near at-risk populations. Institutional and commercial wood systems burners typically burn with very low levels of undesirable stack emissions and are required to meet state emissions standards. Like all boilers, wood heating systems have stacks to exhaust the resulting emissions, and breaching to connect the boiler to the stack. Larger woodchip boilers frequently employ emission control devices between the boiler and the stack to further control the amount of fine particulates emitted. Smaller wood pellet and cordwood boilers do not typically require additional emission control technologies to meet air quality standards.

SYSTEM CONTROLS

The conditions for efficient wood fuel combustion are set by controlling the rates at which fuel and combustion air are fed to the fire. The simplest systems have on/off fuel feed. When the boiler water temperature drops below a set value, this type of system turns on and supplies fuel (and combustion air) to the fire until the water temperature is brought back up to its set value. Then the system shuts off the fuel feed system and combustion air. Most woodchip systems have controls that allow the system to go into an idle mode so they can hold a flame during periods when there is little or no load without requiring automated or manual re-ignition. More sophisticated systems use a control strategy with multiple, separate firing modes. Controlling how the system switches back and forth between the different firing modes (such as low, medium, and high) can achieve a much greater degree of control and a very good turn-down performance. It also avoids the potential for smoking when an on/off system switches frequently out of its "off" mode. The most precise combustion control can be achieved when the rates at which fuel and air are fed to the fire can be automatically varied or modulated.



In addition to combustion controls, system controls integrate other components, such as backup boilers and thermal storage with the woodchip boiler, which can improve overall system efficiency and emissions.

ASH COLLECTION

Ash — unburnable minerals in the fuel, mixed with any unburned carbon — accumulates in the combustion chamber and the heat exchange routing and needs to be removed regularly. For every ton of green woodchips burned, there is typically only 25 pounds of ash produced. Most of the ash accumulates in the combustion chamber — this is called bottom ash. If there are sloped or moving grates, the ash moves to the bottom of the grates. It is important that this ash be removed on a continuous or daily basis. One method is removal by automatic ashing augers (also called screws), which collect ash at low points and move it outside the combustion chamber. Automatic ashing is sometimes preferred, since it reduces maintenance time for staff. However, it can add capital cost to the system. Many plants, including some relatively large ones, use manual ashing: the ash is raked and shoveled out of the boiler by hand, a task that typically takes about 10-20 minutes a day. In most systems, manual ashing can be done easily without shutting down the boiler.

Fly ash or fine ash that is often carried with hot combustion gases from the primary combustion chamber can be filtered from the gas stream and with larger boilers the fly ash is typically collected in separate containers for storage and eventual reuse. Smaller boiler systems tend to collect the fly ash and co-mingle it with the bottom ash.

Thermal Storage

Thermal storage can provide many benefits when properly designed, installed and controlled in conjunction with wood-fired hydronic heating systems. The idea behind thermal storage is to prolong the operation of the boiler, providing greater efficiency and responsiveness to load.

For a discussion of this component, see [Chapter 5 – Modern Wood Heat System Design Considerations, Thermal Storage](#).

Cordwood Systems

Modern cordwood systems use wood-fired combustion and gasification (“two-stage”) technology to achieve high efficiencies and burn at temperatures between 1,800-2,000°F. They differ from older cordwood boilers in their use of modern controls and automation features. For cordwood boilers thermal storage (in the form of a large-volume hot water tank) is essential – allowing batches of fuel to be burned quicker, at higher temperatures, higher efficiency, and with fewer emissions. The fire is stoked periodically (once or twice a day in cold weather) to charge the water storage with heat. This keeps the fire continually hot, fast, and clean, unlike old wood stoves or cordwood boilers that burn less efficiently when less heat is called for. Once charged, a circulating pump removes heat from the tank as needed to serve the space heat or domestic hot water requirements. This allows for shorter, more efficient burn cycles and full heat recovery otherwise wasted as fuel in the fire-box slowly dies out.

Each system includes a cordwood boiler, an induced draft fan, controls, and stack connection. They can differ among companies in configuration of the water storage: either as an integral water storage with the combustion chamber surrounded by the water jacket tank, or as an external thermal storage tank. An advantage of cordwood systems is that cordwood is widely available and can be stored without a costly bin or expensive building construction. Stacking of cordwood will potentially require a large area, and the stacks will need to be sheltered from the elements, under a pole-barn structure or woodshed for example. They are only attractive in cases where the operator wants to hand fire the system. Although they can be used for relatively large loads (up to 1 million Btu per hour), the amount of wood that must be manually handled can become a constraint for the operator.

Pros and Cons of Each Technology

In general, and over the life of a system, wood pellet systems often see better economics at smaller facilities, and woodchips systems at larger facilities.

	+ PRO	- CON
WOOD PELLETS SYSTEMS	<ul style="list-style-type: none"> » Fuel source that is uniform in terms of size, energy content, and moisture content, allowing for fully automated systems. » Highly sophisticated and precise modulation of the amount of oxygen provided to the fire, to ensure optimal burning for the heat demand, and limited air emissions. » Less costly to install than woodchip systems. 	<ul style="list-style-type: none"> » While wood pellets have historically been cheaper per unit of energy than oil, propane, or electricity, they are more expensive than woodchips.
WOODCHIP SYSTEMS	<ul style="list-style-type: none"> » For good performance, woodchips that are uniform in size and moisture content work best, but woodchip boilers can be selected to work for a range of chip quality. » Modern systems allow for the precise injection of combustion air to the fire as needed and can burn with high efficiency and limited air emissions. » Can be designed to be either fully automated or semi-automated. » The cost of woodchips is significant lower than pellets, so for larger facilities that go through a lot of fuel, they may make more sense economically. 	<ul style="list-style-type: none"> » Woodchip systems tend to be more expensive than pellet systems initially, but the cost of woodchips has historically been significantly lower than wood pellets. » Capital costs, particularly for indoor woodchip storage, are high as compared to storage for wood pellets.
CORDWOOD SYSTEMS	<ul style="list-style-type: none"> » Modern boiler systems exist that are semi-automated and allow for effective burning of cordwood. » The fuel cost savings may be worth it depending on local availability. 	<ul style="list-style-type: none"> » The labor requirements for firing with cordwood must be considered. » Most systems require seasoned cordwood which requires maintaining a large inventory of fuel. Alternatively, and for an additional cost, kiln-dried cordwood could be used.



5 Modern Wood Heat System Design Considerations

Several parameters, which are discussed in this chapter, need to be considered when designing and installing a modern wood heating system.

In addition to the type of technology installed, the climate and how to handle variable demand for heat need to be taken into consideration. The facility's existing heating and heat distribution systems, as well as domestic hot water needs should also be factored into the design. Finally, air emissions should be considered and mitigated as needed.

Understanding Annual Heat Load

In order to determine the monthly, daily, and hourly thermal loads that will inform the size of a boiler, daily temperature and Heating Degree Day (HDD) data are usually collected. Heating Degree Days are simple units of measure for heating requirements based on outside temperature data. One heating degree day is the equivalent of one full day that is one degree cooler than the conceptual set point of 65 degrees Fahrenheit.¹¹ For example, if the temperature outside is 55F, or ten degrees colder for one day, then that is ten heating degree days. All of the heating degree days for each year are added up to get the annual heating degree days. Generally, if one heating season has 20% more HDD, then a building will need 20% more fuel to keep the building's temperature at a given set-point. HDD can greatly vary from year to year, illustrating the variability of weather year to year in predicting heat demands and potential fuel savings in a fuel-switching project. Considering several years of HDD data can help alleviate this issue.

Figure 10 provides a different perspective of the weather data. The bar graph illustrates the typical distribution of cumulative time (hours) at a specific outside temperature during a typical heating season. This is important because it clearly illustrates that while more fuel is consumed when it is below twenty degrees Fahrenheit (in this example) and a bigger capacity heating system is needed at these times, a large majority of the annual heating demand is made up of times when temperatures are between 20 and 65 degrees Fahrenheit, in this example.

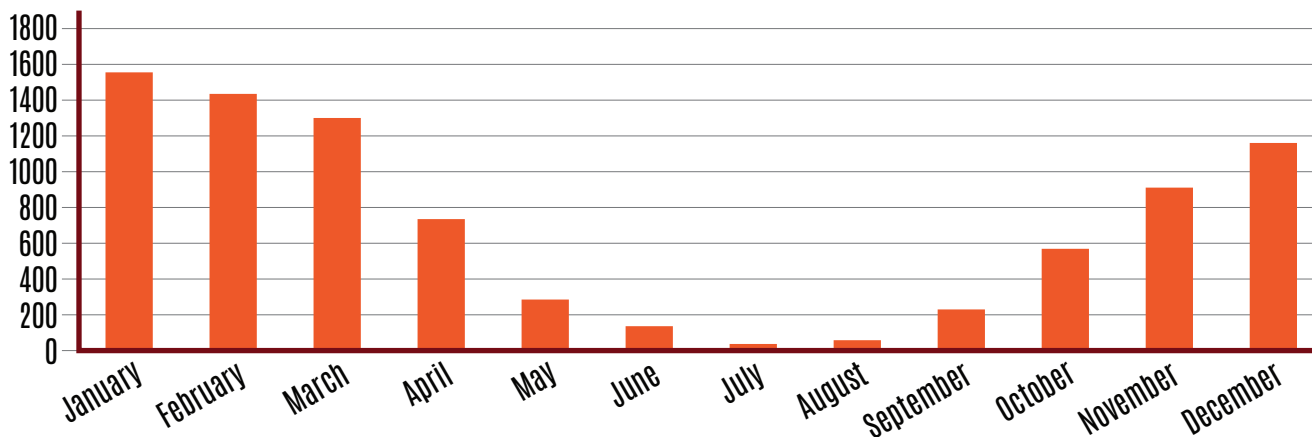

FIGURE 10: Example of Annual Heating Degree Day distribution (3-Year Average Northfield, VT)

¹¹ Another set-point may be chosen depending on building characteristics and internal heating load present.

Figure 11 illustrates why it can be important to size a wood boiler to cover most of the heating needs over one year, while a backup heating system or large thermal storage tank provides heat for the few hours when the temperature dips to its lowest. Proper sizing of a boiler typically takes HDD into account as well as how many hours are spent annually at each temperature (“temperature bin data”), as well as physical characteristics of a building (e.g. rate of heat loss from the building envelope, domestic hot water requirements, etc.).

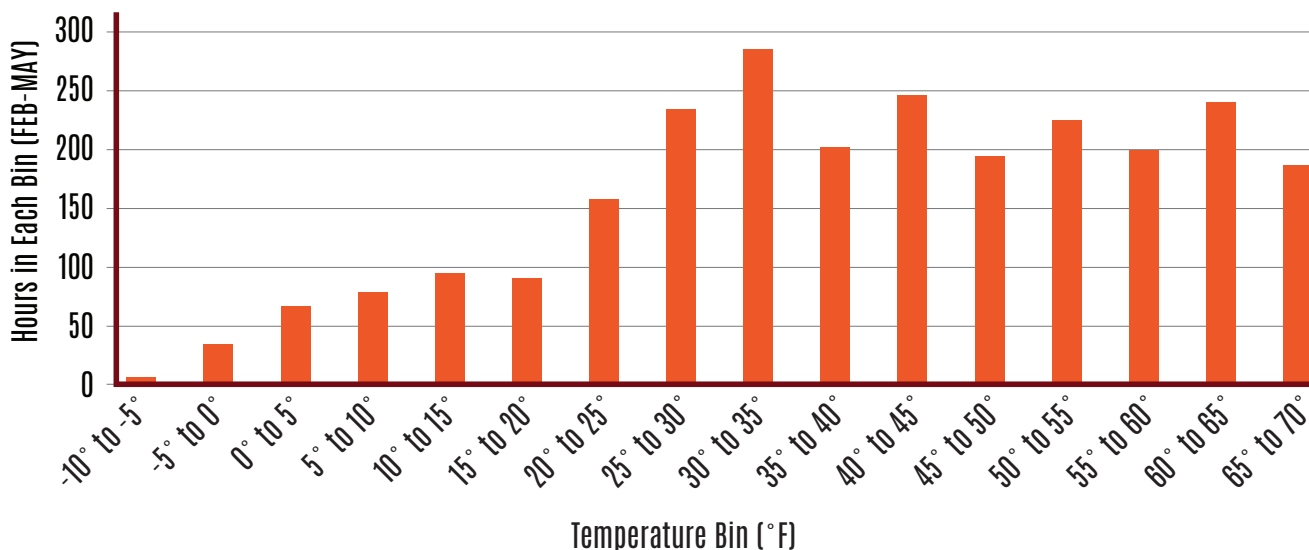
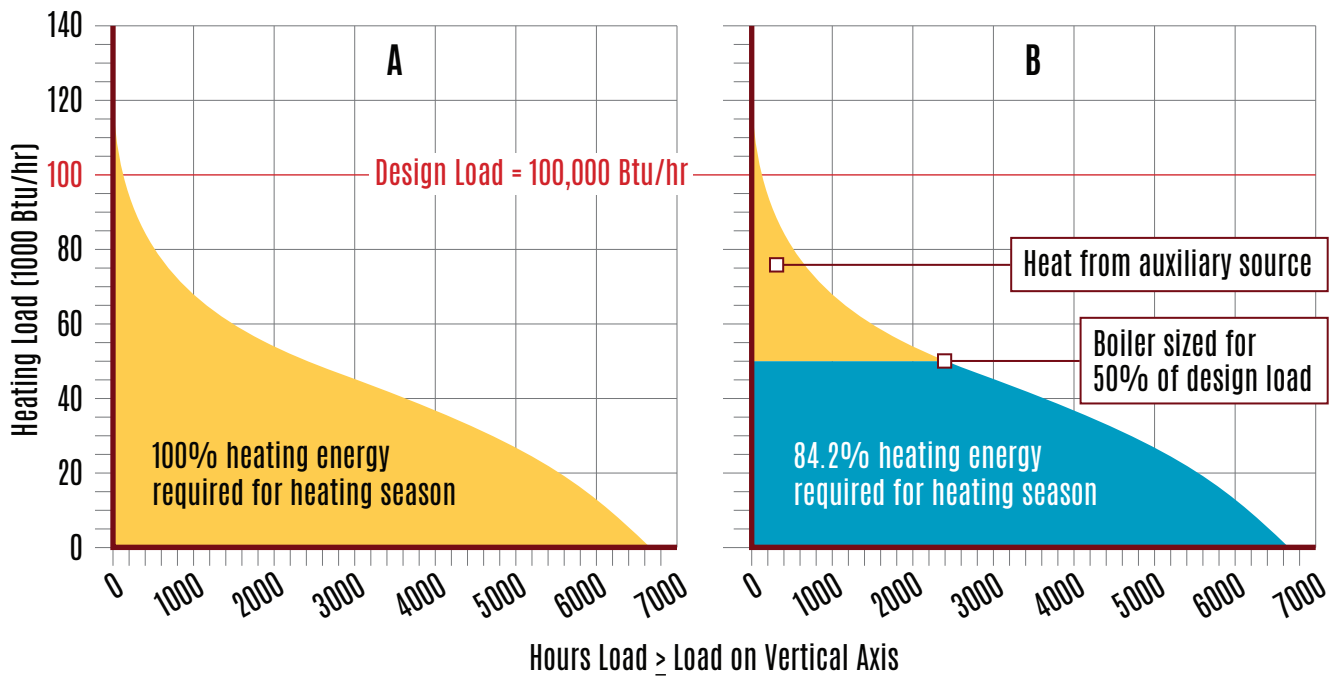

FIGURE 11: Example of Annual Temperature Bin

Generally, there is an inverse relationship between the outside temperature and the demand for heat throughout the year. The three coldest months of the year in the Northeast are December, January, and February and these months can account for nearly half of the annual heating load of a facility.

Wood Boiler Sizing and Backup Boilers

The concept of temperature bins and resulting heating load can also be represented with a heating load curve (Figure 12), where the number of hours (horizontal axis) spent at various heat requirement levels of the building (“heating load”, vertical axis) are added up and organized in ascending order in terms of number of hours. For example, very few hours are spent at the maximum heating load (the “design load”), because, as illustrated in the temperature bin data, very few hours of any given year are spent at the coldest temperature. Most of the hours occur when the temperatures, and resulting heating load, are more moderate (represented by the majority of the curve below the 60,000 Btu/hr in the example illustrated). If the boiler was to be sized for the design load (the coldest day of the year), it would have to be turned down greatly for most of the hours that it is in operation.



Data courtesy of John Siegenthaler

FIGURE 12: Heating load curves for boilers sized for peak design load (A) and 50% of design load (B)

When a modulating wood boiler system¹² is turned down significantly, combustion becomes less efficient and the resulting emissions increase. As modulating wood boilers cannot be turned down more than a set amount, if the heat demand of the building becomes too small for the boiler, one of two scenarios will happen:

- » If it is a pellet system or a dry woodchip system that can be automatically ignited, it will go through cycles of shutting down and re-starting (“short-cycling”), or
- » If it is a large green woodchip boiler that does not cycle because it lacks the automatic ignition capabilities, it will go into a standby mode, where the wood fuel is burned very slowly and inefficiently (“glow” mode) so that it can more rapidly come back to full-power mode.

The times when a boiler is shutting down and re-starting are the periods when the burning of wood is least efficient and when emissions are at their worst. Thermal storage (discussed below), when properly installed, can help overcome this short-cycling issue.

The size of the boiler(s) will be dependent on the heat demand of the facility, which in turn is dependent on the size of the facility and the thermal envelope (how well the facility is insulated).

¹² Cordwood boilers do not modulate, they are typically designed to burn at full load to recharge the thermal storage, then shut down

Facilities that need more than 60,000 Btu per square feet should consider tightening the building prior to installing a wood heating system, to avoid the potential for the boiler to be over-sized if weatherization takes place subsequent to the wood heating system design and installation.

An engineer or system installer will need to perform a detailed analysis to properly size the boiler.

Modern wood heating systems can be designed with a single or multiple wood boilers and with and sometimes without a fossil fuel back-up system.

Single Wood Boiler Scenario

If a wood boiler were sized for 50% of the peak design load, for example, then 80-90% of the heating needs over a whole year would be taken care of by the wood boiler (represented by the blue area in Figure 12 graph B, and the arrow in Figure 13).

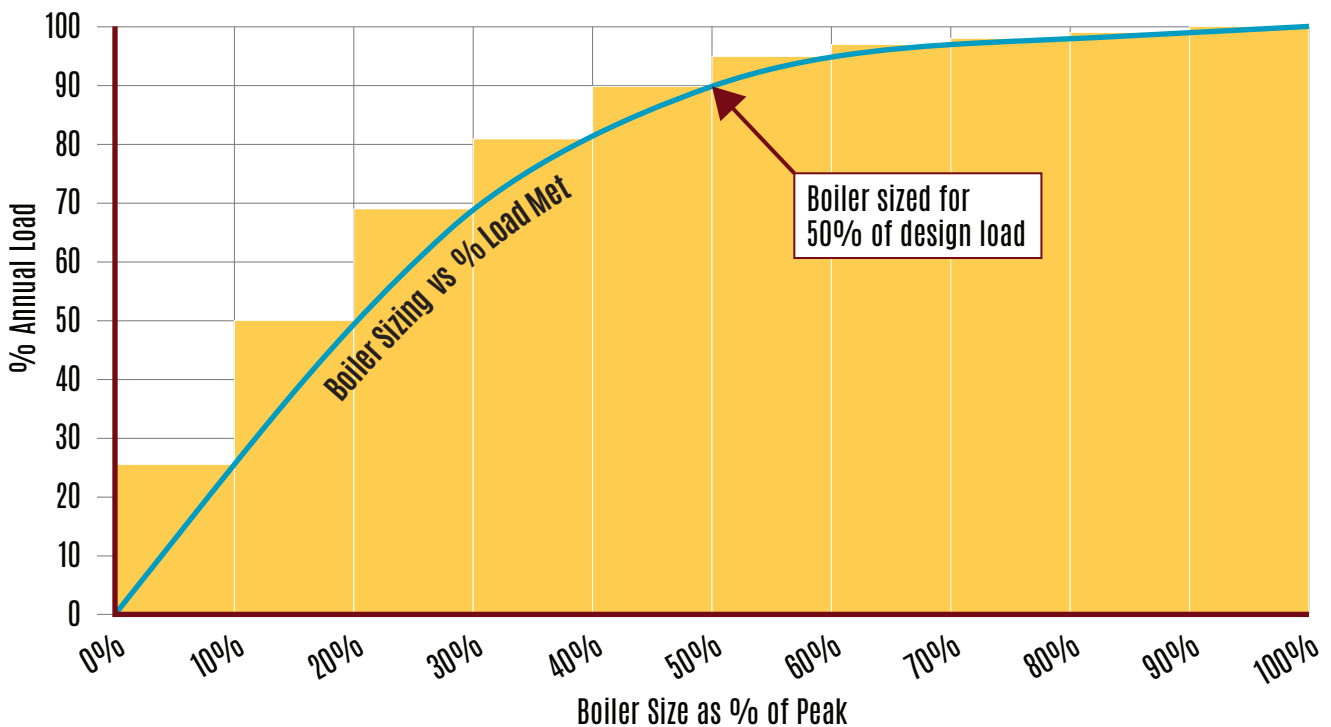

Data courtesy of Kohler and Lewis Engineering

FIGURE 13: Boiler Sizing vs. % Load Met: Graph illustrating the relationship between boiler size as percent of peak heat demand and the percent of annual heating load covered (arrow indicates an example of a boiler sized for 50% of peak load that covers 90% of the annual heat load.)

Properly sizing a pellet or woodchip boiler is extremely important to avoid short-cycling or long periods of run-time in low-fire or standby mode, and to achieve expected performance levels, in terms of efficiency, fuel consumption (and costs), and emissions.

Single Wood Boiler with Backup Fossil Fuel Boiler Scenario

There are several ways to meet the heating needs of a building and avoid over-sizing of the wood boiler. One is by installing or keeping a backup fossil-fueled boiler that can meet the additional heat demand during the short periods of extreme cold weather (yellow area in Figure 12 graph B). The backup fossil fuel boiler can also carry the heat demand during the shoulder heating seasons when there are only short periods of time when a little heat is needed. Therefore, a backup fossil fuel boiler can reduce the on-off cycling and the amount of time that the wood boiler spends in low-fire/standby mode over the course of the heating season. The backup fossil fuel boiler can also be used to meet the full heating demand if the wood system goes down unexpectedly or for scheduled maintenance, or if the storage bin is empty.

Two or More Wood Boilers Scenario



FIGURE 14: Example of two small pellet boilers (red) coupled with a thermal storage tank (large white insulated tank on left).

Another way to provide the optimal boiler output capacity is to install two or more smaller wood boilers in parallel, rather than one large one (Figure 14). This allows greater flexibility to meet fluctuating heat loads with either one of the boilers or several working together. This also allows for back-up redundancy, if one of the wood boilers needs maintenance.

Determining optimal wood boiler configuration and sizing should be based on a mechanical engineer's design and a final decision should be made in consultation with the selected wood system vendor/contractor.

Thermal Storage

Thermal storage acts as a buffer between the combustion system and the heat load — typically using a hot water storage tank that allows for more even and regulated boiler performance in response to changes to demand for hot water from a building. The idea behind thermal storage is to prolong the steady load runtime of the wood boiler and provide improved responsiveness to changes in the facility's heat demand.

Thermal storage can provide a wide range of benefits:

- » Improved system efficiency
- » Reduced particulate emissions
- » Reduced wear and tear on wood heating system
- » Reduced peak output capacity requirement for wood boilers

When a wood boiler satisfies a temporary heat demand for a building and further hot water is no longer needed, the buffer tank(s) allows the wood boiler to continue to run to charge the tank before turning down or shutting down, and capture the heat given off as the system slowly burns down the fuel in the combustion chamber. Later, when there is a call for additional heat from the building, system controls signal the buffer tank to provide the needed hot water without requiring an immediate response from the boiler.

Properly designed thermal storage achieves temperature stratification in the buffer tank – with the hottest water at the top and the coolest temperature at the bottom (Figure 15). When hot water is supplied from the boiler to the buffer tank it is delivered to the top of tank and when hot water is needed by the building, it is drawn off the top of the tank. Conversely, when cooler water is returned from the building's hydronic loop it is delivered to the buffer tank at the bottom. Return water supplied back to the boiler from the buffer tank is also drawn off the bottom.

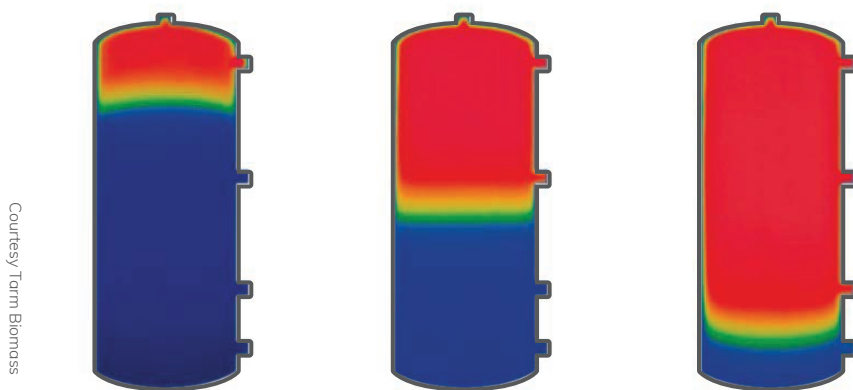

Courtesy Tom Blomss

FIGURE 15: Illustration of proper temperature stratification in a buffer tank when nearly depleted, partially charged, and fully charged.

For cordwood boilers thermal storage is essential – allowing batches of fuel to be burned quicker, at higher temperatures, higher efficiency, and with fewer emissions. For pellet boilers with automated fuel feeding systems and the ability to modulate their heat output, thermal storage can dramatically reduce the number of start-up/shut down cycles (“short-cycling”) when there is insufficient load to maintain continuous operation. Similarly, thermal storage can ensure modulating pellet and woodchip boilers spend a greater percent of their runtime in high-fire mode when performance and efficiency are optimized and air emissions are minimized.

Thermal storage should always be considered as a vital component of a boiler system (pellet, woodchip or cordwood) to help the boiler meet maximum peak output requirements, by allowing under-sizing of the capacity of the boiler to less than 100% of the peak output to meet the needs for the coldest hour of the day of the year. An oversized boiler attempting to meet a load that is less than its minimum output without thermal storage, or without sufficient thermal storage, will operate by constantly switching on and off, resulting in under-temperature operation of the boiler, inefficient combustion and excessive emissions of pollutants. In addition, thermal storage can allow for a faster response to rapid changes to thermal needs such as large and sudden swings in outdoor temperature. Lastly, thermal storage allows for the integration of the wood heating system with a solar hot water system, by providing a single hot water tank that is integrated into both systems.

Typically, the capacity of the boiler determines thermal storage tank sizing. Proper sizing of buffer tanks can range from 750 to 5,000 gallons per million Btu/hr of boiler capacity, depending on many factors including the building’s hot water load demand profile, the thermal mass of the building and distribution system. While there are general rules of thumb commonly used for sizing thermal storage but an experienced mechanical engineer should make the final determination of the need for thermal storage, proper sizing and configuration.

Some wood boiler manufacturers assert that they have designed their boilers such that a thermal storage tank is not essential; however, this does not mean that the incorporation of a thermal storage tank would not be beneficial to the end user. As well as offering protection to the boiler by dissipating heat in case of a power outage, a thermal storage tank is likely to improve the overall seasonal operating efficiency of the boiler system.

Domestic Hot Water

In addition to providing hot water for space heating, wood heating systems can provide domestic hot water (DHW). Historically, larger wood-chip boilers were typically configured to supply heat and DHW during the main heating season, but the back-up fossil fuel boilers covered the DHW loads in the summer months and shoulder heating seasons. Today, with improved wood combustion technology, the coupling of multiple boilers, thermal storage, and quality controls, wood boilers are being more frequently designed to fully cover the space heating and year round DHW loads. Determining the optimal sizing of the wood boiler(s) and buffer tank(s) will need to factor (in addition to the base heating load) the frequency, intensity, and duration of the domestic hot water loads.

Existing Heating System Configuration

The configuration and condition of the existing heating system will, to some extent, determine what is economically feasible and what wood heat solution is best suited. For example, the temperature requirements of the hydronic distribution system, or whether the distribution system is steam or hot water, will affect the set-up of the wood boiler and its components. Whether the existing boiler can be retained as backup will also greatly impact the sizing of the new wood boiler.

Emissions from Wood and Fossil Fuels

First and foremost, all modern wood heating systems are required to meet applicable state and federal air quality regulations. Emissions limits and control technologies often vary with the size of the boiler in question. Modern wood heat systems produce virtually no visible emissions (although chip and cordwood systems often produce a white plume of water vapor on cold days). However, all combustion processes — whether the fuel is oil, gas, or wood— emit a variety of invisible compounds. All heating fuels— including wood—produce emissions in varying amounts of:

- » particulate matter (PM)
- » carbon monoxide (CO)
- » nitrogen oxides (NO_x)
- » sulfur dioxide (SO₂)
- » a variety of organic compounds (usually referred to as volatile organic compounds –VOCs- or total organic compounds-TOCs)
- » carbon dioxide (CO₂)

Compared with heating oil, natural gas, or propane, wood is a more variable fuel with respect to heat content, moisture content, and combustion characteristics. Consequently, emission rates are variable but also depend on the combustion technology and conditions. For example, in general, burning wood in a modern and well-maintained woodchip boiler produces slightly more particulate matter than burning oil.

Table 5 below provides typical emission rates (in pounds per million Btu), comparing a commercial-sized woodchip boiler without any PM control technology (such as an Electrostatic Precipitator) with comparable oil, natural gas, and propane systems.¹³

	WOODCHIP BOILER	DISTILLATE OIL	NATURAL GAS	PROPANE
PM 10	0.100	0.014	0.007	0.004
Total PM	0.12	0.024	0.0075	0.0077
NO _x	0.19	0.14	0.098	0.14
CO	0.18	0.036	0.082	0.082
SO ₂	0.025	0.0015	0.0006	0.011
TOC	0.039	0.004	0.010	0.011
VOC	0.017	0.0024	0.0054	0.011
CO ₂	30*	159	118	137

TABLE 5: Typical emission rates for commercial sized woodchip and fossil fuel boilers

*Source: <http://www.biomasscenter.org/pdfs/veic-carbon-emission-and-modern-wood-heating-summary.pdf>

In terms of health impacts from wood combustion, **particulate matter (PM)** is the air pollutant of greatest concern. Particulates are solid matter, ranging in size from visible to invisible. Relatively small PM, 10 micrometers or less in diameter, is called PM10. Small PM is of greater concern for human health than larger PM, since small particles remain air-borne for longer distances and can be inhaled deep within the lungs. Particulate matter exacerbates asthma, lung diseases and increases risk of mortality among sensitive populations. Fine particulates, 2.5 micrometers or less in diameter (PM_{2.5}), are increasingly of concern, as they are known to increase health-related problems more than the larger particulates. There is no established safe level (concentration) of exposure to fine PM, so lower exposure is always better with regards to health impacts.

¹³ Data compiled from EPA AP42, Resource Systems Group, and emissions testing from numerous woodchip heating systems.

For example, over the course of a heating season the woodchip system of a large (200,000 square foot) Vermont school produces about the same amount of particulate matter emissions (PM) as five typical home wood stoves.¹⁴ All but the very best and largest wood burning boilers, however, have significantly higher PM emissions than do corresponding gas and oil systems. Compared to home heating, larger wood heating systems at schools are big enough to make it technically and economically feasible to install best available control technology (BACT) for further reducing particulate emissions.

Combustion of any fuel produces carbon monoxide (CO). The amount produced depends very much on how well a given boiler system is tuned. CO emissions from burning wood fuels are of relatively minor concern to air quality regulators. However, it is important to note that CO is a sign of incomplete combustion and CO levels are frequently used as indicator of other pollutants like organic compounds.

TOCs are a large family of air pollutants, some of which are produced by fuel combustion. Some are toxic and others are carcinogenic. In addition, the VOC subset of TOCs contribute to the formation of ozone and elevate smog levels in the lower atmosphere, causing respiratory problems. Good combustion practices can minimize TOC emissions.

Ensuring that the facility is fitted with the “best in class” combustion systems and, in some cases, best available controls and that the stack is tall enough to disperse any remaining emissions is typically all that is needed to address potential concerns regarding air emissions from modern wood heating systems.¹⁵

Air Emission Control Technologies

The smallest institutional and commercial wood heating systems may not be required to install additional equipment to meet state emissions standards. Nonetheless, most system manufacturers routinely install devices to remove particulates from the exhaust gases, regardless of unit size (the exception being small systems below 1 MMBtu). These devices, called cyclone separators or multi-cyclones, mount between the heat exchanger and the chimney connection. Systems with particulate removal devices always have induced draft fans, which create a negative pressure in the combustion chamber and assure proper movement of flue gases up the stack.

¹⁴ Assumes 5 cords per year fuel consumption

¹⁵ Modern wood heat systems purchased or installed after December 15, 2016 that have a heat input rating of less than 2.5 MMBtu/hr must comply with the requirements of §5-204 of the Vermont Air Pollution Control Regulations. Included in this Vermont regulation is the requirement that the affected system to be certified by the U.S. EPA as meeting the applicable standards and requirements under 40 C.F.R. §60.532

Currently, the four most common air pollution control devices used to reduce PM emissions from wood-fired boilers are:

- 1) Mechanical collectors (single cyclones and multiple cyclones),
- 2) Electrostatic precipitators (ESPs),
- 3) Fabric filters, and
- 4) Wet scrubbers.

With the exception of mechanical collectors, these devices can reduce PM emissions by 70 to 99.9%. It is highly recommended to install the best available control technologies to wood heating systems in community settings because of the particular vulnerability of certain populations to health impacts from fine particulates released by wood combustion.

Systems greater than 10 million Btu/hour need to meet specific EPA Maximum Achievable Control Technology rules (MACT rules). In Vermont, any wood boiler with more than 900 square feet of heat transfer surface area¹⁶ is required to secure an air quality permit from the Vermont Agency of Natural Resources. Designers of larger systems, above this permitting threshold, work with regulators to determine allowable emission rates and best available control technologies on a case-by-case basis. Recent permits have required a filterable PM emission rate of 0.030 lb/MMBtu. Smaller wood heating systems that do not require a state permit, should still be designed and installed in accordance with best practices and should limit PM emissions to below 0.1 pounds per million Btu. Local regulations and State Act 250 regulations may vary by region. In recent years numerous woodchip fired boiler systems (as small as 2 million Btu/hr) have been installed in the Northeastern US with electrostatic precipitator (ESP) control systems. Stack testing results indicate these systems are achieving PM levels well below typical emission rates for oil fired boilers. One recent emission test on a woodchip boiler equipped with an ESP reported 0.009 lbs/million Btu for PM₁₀, nearly on par with PM emissions typical for natural gas.

Stack Height

Stacks should be designed with sufficient height to effectively disperse any remaining emissions into the air and minimize ground-level concentrations of PM (and other pollutants) to ensure acceptable levels are maintained. For larger facilities considering installing a wood heating system, building owners should consider commissioning an emission dispersion modeling study to account for weather patterns, local topography, neighboring facilities, and wind directions to determine the appropriate dimensions and location of the stack. Dispersion modeling may also be required by air quality regulators for systems over a certain size threshold.

¹⁶ 900 square feet of heat exchange surface area is roughly equivalent to 4.5 million Btu of output capacity.

6 System Operation and Maintenance

Modern wood heat systems are relatively simple to operate, but do need some regular maintenance. This chapter provides an overview of what tasks are involved.

Vorkauftemperatur	86,2 °C	O ₂ Gehalt Rauchgas	8,12 %
Rücklauftemperatur	86,2 °C	Leistungsregler	0,0 %
Rauchgastemperatur	127,9 °C	Malenregler	0,0 %
Feuertemperatur	568 °C	Einschubblauze	58 mm
Leistung	113 kW		

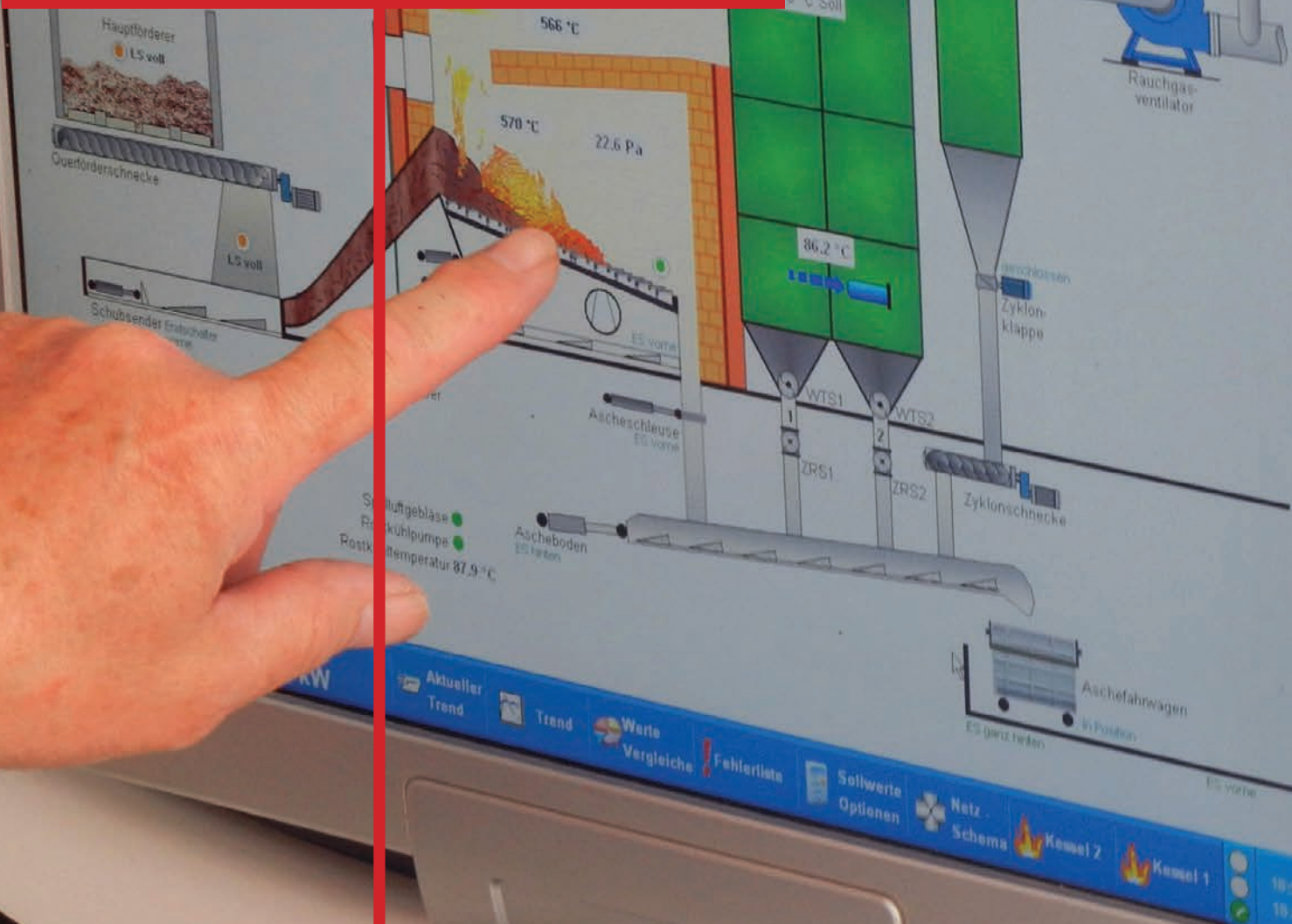

Ash management and monitoring of the proper operation of the system are the primary maintenance tasks required for fully-automated systems. Cordwood systems will require additional handling of the wood fuel to feed it to the boiler.

Pellets

Wood pellet boilers are relatively simple biomass heating systems. Because wood pellets are generally uniform in size, shape, moisture and energy content, fuel handling is very straightforward. Nevertheless, there are some ongoing maintenance requirements for these systems.

A wood pellet boiler will take more time to maintain and operate than a traditional gas, oil, or electric heating system. At the institutional or commercial scale, however, many of the maintenance activities can be cost-effectively automated by installing off-the-shelf equipment such as soot blowers or automatic ash removal systems. Some of the typical maintenance activities required for wood pellet systems are:¹⁷

Weekly

- » Emptying ash collection containers
- » Monitoring control devices to check combustion temperature, stack temperature, fuel consumption, and boiler operation
- » Checking boiler settings and alarms, such as those that alert to a problem with soot buildup

Yearly

- » Greasing augers, gear boxes, and other moving parts
- » Checking for wear on conveyors, augers, motors, or gear-boxes.

When considered on a daily basis, the total time required for maintaining the wood pellet boiler system equates to roughly 15-30 minutes per day over the entire heating season.

¹⁷ The following list is meant for comparison only. Always refer to manufacturer recommendations for actual maintenance schedules.

Woodchips

The maintenance activities required for a woodchip boiler are similar to those of a pellet boiler, with the addition of the maintenance of any equipment required to move woodchips from storage in the case of semi-automated systems. Some of the most important maintenance tasks for most systems are:

Daily or Weekly

- » Ash removal — grates (may be automatic)
- » Ash removal — under grates
- » Boiler tube cleaning (usually automatic,)
- » Fly ash removal
- » Cleaning of fire box and other heat exchange surfaces
- » Lubrication of grease fittings for fuel conveyance

Yearly

- » Inspection of drive chains, belts and gearboxes
- » Inspection of refractory
- » Checking of safety devices; and
- » Checking and adjustment of fuel feed rates and combustion air
- » Boiler tuning and control optimization

Cordwood

Cordwood boilers are typically more labor-intensive to operate because the fuel needs to be loaded manually one to several times each day. In addition, as for wood pellets and woodchips systems, regular maintenance is required, such as:

Daily or Weekly

- » Ash removal from upper and lower chambers
- » Fly ash removal

Yearly

- » Clean fire tubes with a wire brush

Wood Ash Management

Wood ash has a high pH and contains many helpful minerals and micro-nutrients. If stored, handled and applied carefully, wood ash can be beneficially used as a soil conditioner and lime substitute for lawns, gardens, and farm fields. Wood ash can be dusty and because of its high pH it is caustic – it needs to be stored and handled carefully.

Many schools in Vermont, for instance, with wood heating systems simply store their ash on site and periodically spread the ashes on their athletic fields or other green areas.

In Vermont typical amounts of wood ash produced by wood heating systems in multi-family apartment buildings is not regulated and can be beneficially reused. However, large facilities producing 500 tons of wood ash or more annually need to report all wood ash management activities to the VT Agency of Natural Resources, Department of Environmental Conservation (ANR DEC).

Always check your local requirements first, as there may be local restrictions on where to dispose of wood ashes in your community. The ANR DEC website provides contact information for permit specialists.

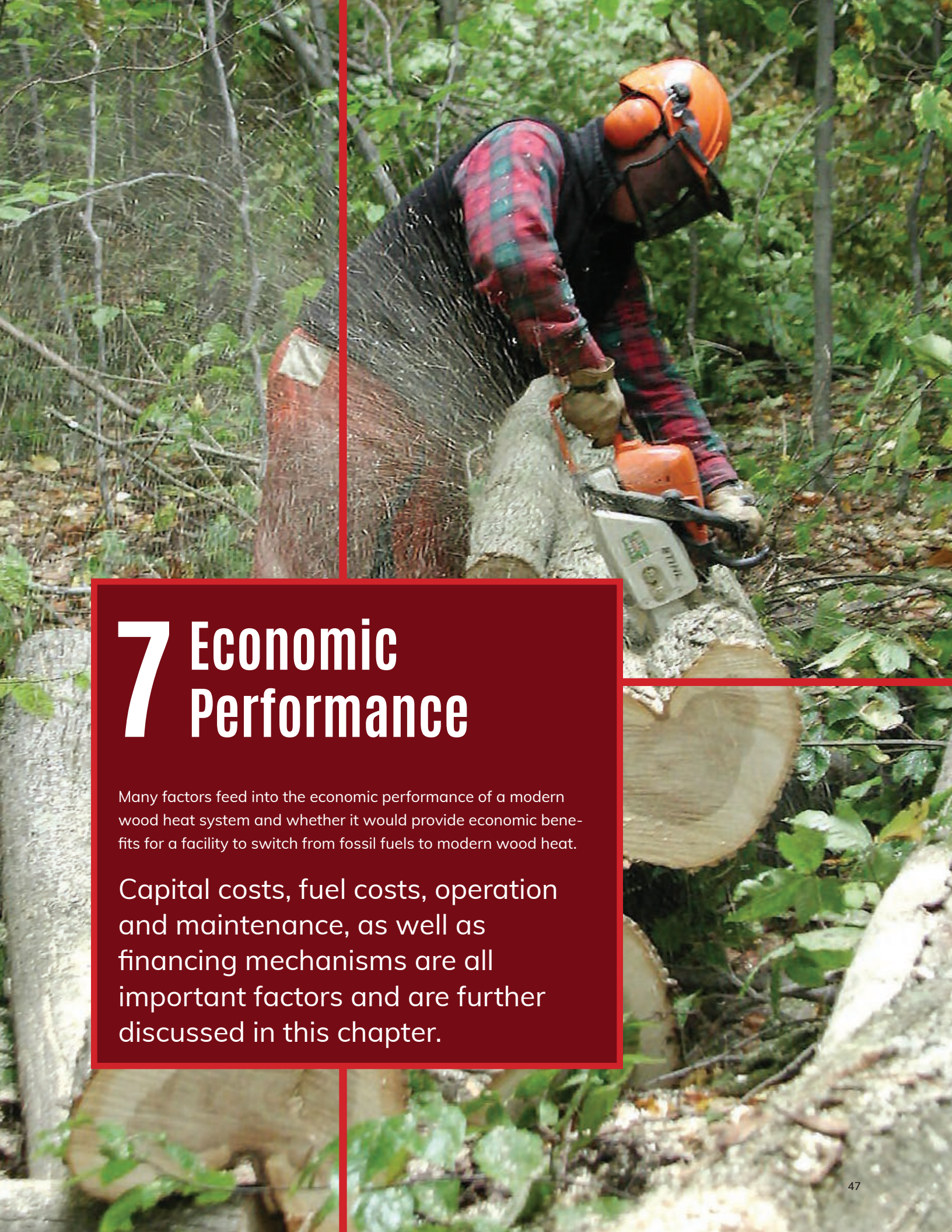

7 Economic Performance

Many factors feed into the economic performance of a modern wood heat system and whether it would provide economic benefits for a facility to switch from fossil fuels to modern wood heat.

Capital costs, fuel costs, operation and maintenance, as well as financing mechanisms are all important factors and are further discussed in this chapter.

Economic Analysis

As a general rule, modern wood heat systems are most cost-effective when:

- » Space-heating, electricity and fossil fuel prices are relatively high,
- » Energy consumption is relatively large,
- » They are an alternative to another new system, rather than a replacement for a system currently in use, and
- » The facility has a hydronic (hot water) heat distribution system already in place.

In a very simple analysis, the fuel dollar savings over the life of the boiler can be **combined with** a rough estimate of system cost and **compared to** a business-as-usual situation. A forecasted rate of escalation in fuel heating prices is factored in for each fuel. That rate can be different for different fuels to reflect historical trends. If a project is financed, the costs of debt service are included over the timeframe of the loan. If a 30-year analysis timeframe is used and the project is financed over 15 or 20 years, there is usually a clear stepwise drop in costs when the loan is fully repaid (as in year 20 in Figure 16).

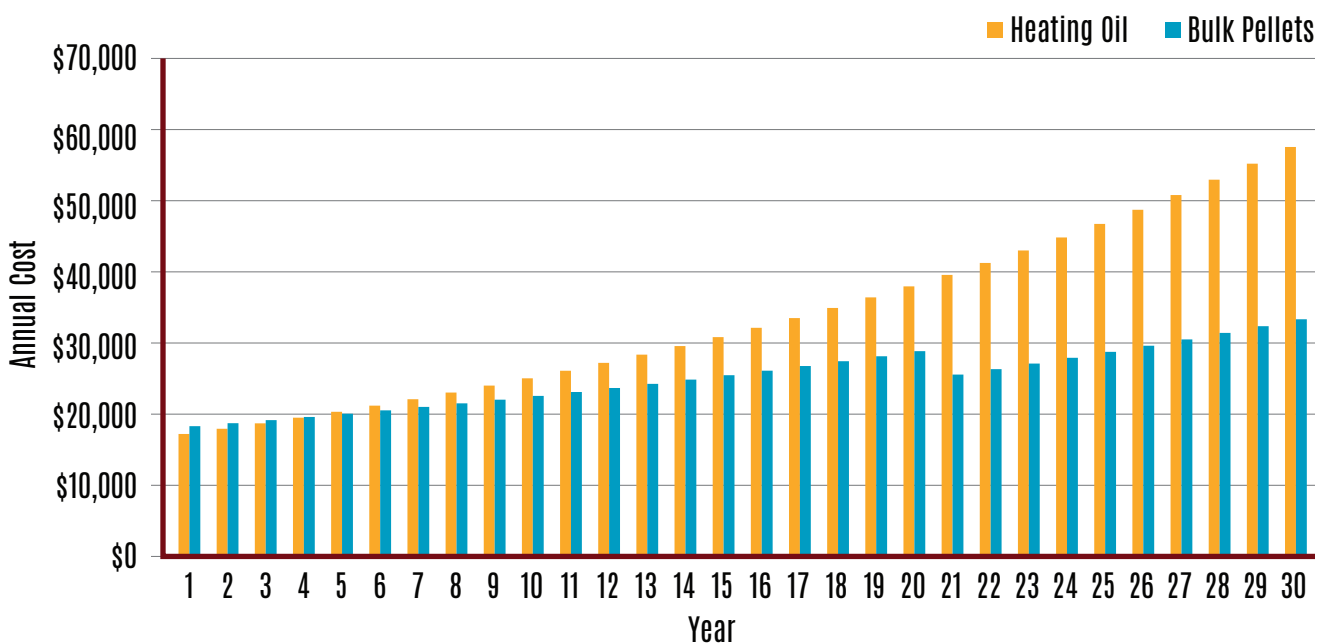

FIGURE 16: Example of a 30-year economic analysis comparing the annual costs of heating oil vs. a new wood heating system

A financial analysis can focus on a number of methods to estimate cost-effectiveness:

- » **Simple payback** is the number of years it takes to recover the initial investment, based on the size of the investment and the first-year net cost savings— including costs for energy, operating, and maintenance. This calculation is a useful tool for obtaining a quick, rough indication of the benefits a project may provide. Unfortunately, it has little application beyond that. It cannot tell whether a project is cost-effective.
- » **First-year cash flow** is simply a determination of whether the project's cash outflow in the first year (usually just the first year's loan payment) is greater than the first-year fuel savings (and any other savings) that the project generates. A wood-chip system investment with a negative first-year cash flow could still be very positive in the long term.
- » **Life-cycle cost analysis** accounts for future changes in fuel costs of the biomass fuel and the competing fuels. It also considers the cost of financing; looks at differences in maintenance, repair, and replacement costs of the competing options; and takes into account the future value of the dollar.

A life-cycle cost analysis should be included in a pre-feasibility study. For more information on next steps, initial assessments of cost-effectiveness and pre-feasibility analysis, refer to [Chapter 8 – Project Implementation](#).

Project Capital Costs

One of the most important factors influencing total capital cost is whether the boiler can be incorporated in the existing building or whether a new structure needs to be constructed. If a building needs to be constructed, the costs will vary widely depending on the type and size of structure that needs to be built. If a new hot water (hydronic) distribution system needs to be installed to replace a forced hot air, resistance heat, steam, or outdated distribution system, this will greatly add to the project costs.

When several buildings switch to wood heat, it can be more cost-effective to install a single heating system in a central plant and connect all the buildings with piping (“district heat system”), than to install several boilers in each of the buildings. Nevertheless, hot water pipes can be costly to install in a district heat system and that cost should be factored in an economic analysis.

Typical capital costs for **wood pellet systems** that can be incorporated into the existing buildings can range from as low as \$50,000 for a small institution to several million dollars for a large building or set of buildings. When a new boiler room to house the wood heating system needs to be constructed or when new piping networks need to be installed to connect multiple buildings, the total cost can be significantly greater.

Typical capital costs for **woodchip systems** can often range from \$80 to \$450 per MBH (one thousand Btu/h) of boiler peak capacity. The smallest, simplest woodchip systems rarely cost less than \$200,000 (including building construction); the total cost of an institutional-size systems is usually \$250,000 to \$750,000, and in the largest installations considered here, a complete wood heating system may cost several million dollars, depending on what infrastructure needs to be built. Costs are highly dependent on system configuration, whether the system is fully or semi-automated, as well as hot water pipes, fuel storage and fuel transportation mechanisms installed.

Capital costs can be broken down into the components listed in Figure 17; however, the actual proportion of each component will be highly project-dependent. In particular, the need for a new building housing the boiler or fuel storage, the size and design of a new boiler house, as well as how much new piping is needed are key variables in determining the total capital costs:

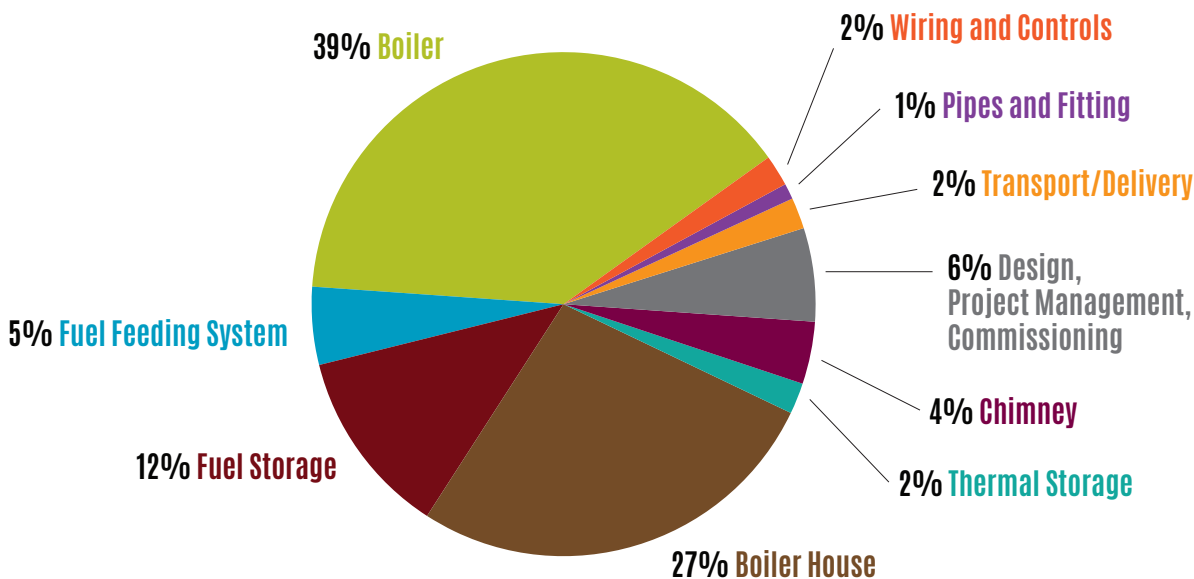

FIGURE 17: Example of capital cost breakdown where a new boiler house is required
Based on BERCC analysis of project costs

Wood Fuel Pricing

Price is often a primary consideration for those considering wood heating. Compared to fossil fuels used for heating, woodchips and wood pellets are an inexpensive fuel source – historically, less than half the cost of oil and propane. Several key factors generally affect the price of wood fuel, including:

- » **Regional supply and demand for the wood fuels.** Pellet and chip prices are most directly impacted by the regional supply and demand balance.
- » **Wood source and production costs:** This varies widely depending on whether the wood used for fuel is a by-product of more lucrative activities (such as milling lumber) or an intentionally produced commodity fuel.
- » **Strength of the sawlog market:** Sawlog harvesting frequently subsidizes the harvesting of low-grade wood products. Increased demand and higher prices paid for sawlogs can help reduce prices for lower-quality wood used to produce chips and pellets
- » **Regional balance of supply and demand for low-grade wood:** Increased demand from other markets such as residential fuelwood, pulpmills, power plants, and pellet mills can influence prices of low-quality roundwood and chips. Similarly, shortages in supply can raise prices. For example, exceptionally wet years can limit harvesting activities, thereby increasing prices.
- » **Trucking distance from point of generation to end market:** The price paid per ton of wood fuel is heavily dependent on the cost of transporting the material.
- » **Amount and seasonality of demand:** Facilities requiring larger amounts of fuel and facilities that purchase chips continually year-round can often leverage slightly lower prices.
- » **Woodchip quality:** Dry chips, chips screened to remove long twigs (which may jam the auger), and chips with fewer impurities (e.g. soil, green material) generally cost more.

Wood heating fuel prices are not directly connected to the world fossil energy market and are less volatile. In addition, wood is a locally produced renewable fuel. For these reasons, the price of wood fuel can be expected to increase less in the future than other fossil fuel prices. For example, woodchip prices in Vermont have increased gradually at about 2% per year over the last fifteen years.

While the capital cost of a new system can be significant, wood heating fuel can be much less costly than the fossil fuel it replaces (see [Chapter 2 – Comparing Heating Fuel Costs](#)) and result in large annual savings on fuel cost. As a result, wood heat systems often see a payback after a few years.

Data collected from school woodchip users shows that woodchips have been historically much less expensive than fuel oil and propane. As an example, schools that have installed woodchip boilers since 2002 have seen an estimated annual fuel savings ranging from \$7,000 to \$123,000 per year (\$0.04 to \$0.64 per square foot per year), or \$61,000 per year on average (\$0.47 per square foot). This is equivalent to 21-63% of the schools' former fossil fuel heating bill (49% savings on average).¹⁸

Operations and Maintenance Costs

Operations and maintenance (O&M) costs can be hard to generalize as they are entirely dependent on the degree of automation of the system and the components installed.

Operation and maintenance costs may range from \$0.75 to \$4 per MBH of boiler peak capacity installed, per year. Another way to approximate O&M costs prior to a feasibility study, is to assume that they will be approximately 5% of equipment portion of the project capital costs.

Financing

Financing is an essential and sometimes difficult part of any wood heat project. In deciding whether to install a woodchip heating system, one of the first questions to consider is how to obtain capital for the project. Institutions, non-profits, or managers of public buildings need to explore the possible sources of financial assistance (such as government grants) and how to raise money to pay for the portion of the project that grants cannot cover. For privately owned commercial and industrial facilities, grants may be less available and the owners will need to rely more on their own funds or commercial debt financing.

Regardless of whether any grant funding is secured, a portion of the capital will likely need to be financed with loans. Public institutions such as schools usually issue bonds to raise this capital; private businesses usually either use internal financing or obtain a loan from a commercial bank. Fuel-cost savings can often be used to make the payments for the bond or loan during the repayment term.

For multifamily housing, modern wood heat may be looked at as a stand-alone retrofit or as part of a larger rehabilitation, and the potential financing

¹⁸ Review of Fuel For School Program data

sources will differ for each. Any subsidy agreements used to establish or maintain affordability (HUD, RD, LIHTC, etc.) will generally have covenants that may dictate appropriate and usable financing strategies and that will also come in to play. The easiest financing is often at the time of rehabilitation when many building systems are being addressed and a complete refinancing of the project is often undertaken. The costs of the new system can be included. The earlier that cost is included in the planning and development process, the more likely it is to be included in construction.

Grants and Loans

In general, grants for the installation of modern wood heat systems fall into two categories:

The first category is construction aid. The [Vermont Housing & Conservation Board \(VHCB\)](#) makes loans and offers grants for the rehabilitation of affordable housing by nonprofit housing organizations.¹⁹ [USDA Rural Development](#) also offers grants that may be available to multi-family housing.²⁰

The second category includes grant and incentive initiatives that are funded by the state renewable energy funds, or energy efficiency funds. Grants may be available through the State of Vermont Department of Public Service's [Clean Energy Development Fund \(CEDF\)](#)²¹, and an incentive may be available through [Efficiency Vermont](#).²²

Third Party Energy Performance / Supply Contracting

Under the third-party approach the financier is paid for project costs it has assumed and then shares the remaining energy savings with the facility owners. The disadvantage of this approach is that the owners must share the net benefits of the project for a certain period. The advantages are that the owners do not have to raise the capital to pay for the installation. The drawback of third-party financing is that energy service companies are most interested in financing energy measures with quick paybacks, and rarely fund projects with paybacks of more than seven years. Capital-intensive wood system projects may have paybacks longer than this. Nevertheless, third-party financing holds some promise for supplying capital for biomass system installations. A carefully structured third-party financing arrangement benefits both the facility owner and the financing entity.

19 <http://www.vhcb.org/housing.html>

20 <http://www.rd.usda.gov/programs-services>

21 http://publicservice.vermont.gov/renewable_energy/cedf

22 <https://www.encyvermont.com/rebates>



8 Project Implementation

This section of the guide describes the steps a typical modern wood heat installation project may go through from concept to full implementation.

While in practice the exact course of a project may vary, the process described allows potential users to approach projects in a logical, structured manner. This will help ensure that best-practice options are selected and increases the likelihood that a high performing, cost-effective system is installed, that meets expectations specific for each site.

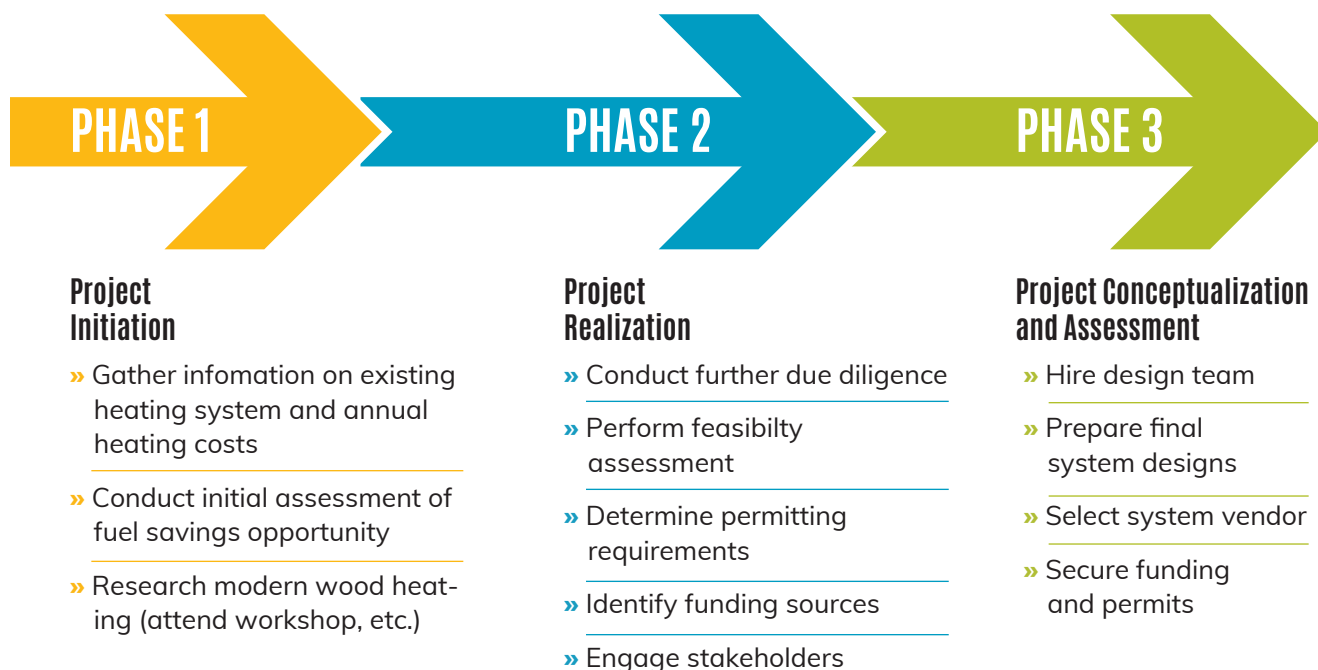

FIGURE 18: A simplified project development critical path

Even though the fuel cost savings from using wood can be significant, the high capital costs of installing a wood system can be a considerable hurdle; therefore, it is essential to correctly select and install the equipment. Building owners considering the installation of a wood pellet or woodchip heating system should begin by taking the following steps:

Phase 1: Project Initiation

Once the idea of a wood heating conversion has taken root, there are a number of simple steps that can be taken to better understand the costs and benefits for a given building. The goal is to understand quickly whether wood is likely to be an appropriate heating solution for the site before investing in further analysis. This phase involves gathering some basic information about your current heating systems and heating fuel usage, conducting a basic assessment of cost-effectiveness, and a review of other potential benefits. You can perform this assessment yourself following the steps outlined below or work with a modern wood heating professional to help you through these steps:

Step 1

To calculate your potential fuel cost savings, you first need to determine the type and amount of heating fuel you use per year and multiply that by your average price per unit. This gives you the total heating fuel bill for the year, to which you will compare your estimated fuel bill if you were using wood (Step 2). For example, if you typically use 11,200 gallons of propane in a year for space heating (excluding any heating fuel that is used for cooking) and your average price over the past year for propane was \$1.75 per gallon, your total average annual fuel bill would be \$19,600.



Step 2

The next step is to estimate how many tons of wood fuel your building requires in a year, using fuel equivalency factors (see Table 6). In the case of propane, one ton of wood pellets is equal to nearly 170 gallons of propane. Approximately 66 tons of wood pellets will be needed to heat for one year (11,200 gallons of propane divided by the equivalent 170 gallons of propane per ton of wood pellets). If the current price of wood pellets is \$260 per ton, your estimated fuel bill using wood pellets would be \$17,160 (66 tons of wood pellets multiplied by \$260 per ton).

	OIL (GALLONS)	PROPANE (GALLONS)	NATURAL GAS (CCF)
1 Ton of Woodchips	69	98	82
1 Ton of Wood Pellets	120	169	142
1 Cord of Firewood	99	140	118

TABLE 6: Fuel equivalency factors

Step 3

The dollar savings from switching to wood pellets in a given year can be calculated by subtracting the estimated annual cost of using wood pellets from your current annual fuel bill. As you project these savings into the future, those prices would change and the gap would increase, since fossil fuel prices will escalate faster than wood fuels.

It can also be extremely valuable at this phase to take time to further research modern wood heating technology and even to tour a few facilities with existing wood heating systems. Seeing this technology and talking with current owners will help you when addressing doubts and concerns you may encounter with stakeholders or the public.

Phase 2: Project Conceptualization and Assessment

The goal of this phase of the project is to acquire all the necessary information on which to make a firm decision on whether to pursue the conversion to a modern wood heating system. If the initial results from Phase 1 indicate favorable financial performance, a more detailed preliminary feasibility (pre-feasibility) study will then determine with greater certainty whether the wood heating project will be cost-effective and if the site is logistically viable for wood heat. A pre-feasibility study will include a preliminary analysis of site-specific data on site heat demand, required system characteristics, logistics, fuel availability, fuel storage, and will estimate potential project capital and operating costs. Facilities may also choose to hire an engineer to explore key issues specific to larger or more complicated projects.

At this point, it is also important to learn about potential state and local permitting requirements. This is also a good time to identify any potential financing and funding sources including any renewable energy incentives and/or grants available (for more information see [Chapter 9 – Resources Available to Affordable Housing Providers](#)).

Almost all the critical questions raised in the early stages of public decision-making on wood heating systems become nonissues when the public is presented with factual information in a thoughtful, well-organized manner. The earlier the public is brought into the process, the better. For public institutions, this process should start while the feasibility study is being done. This way, as soon as there is a demonstrated economic case for installing a wood heating system, the decision-makers will be ready to make a well thought-out case. This guidebook can be used as a tool to inform key stakeholders on the benefits and potential drawbacks of the projects. For municipal or public projects, it is essential to inform the public about the benefits of modern wood heat prior to any vote.

Phase 3: Project Realization

Once a firm decision is made to install a wood heating system, facility owners and managers will secure financing, apply for all necessary permits, and go to out to bid to select the team that will design, engineer, install, and commission the boiler and all associated components (buildings, storage area, etc.).

Fuel Procurement

Wood fuel procurement refers to the selection of a distributor and establishment of a contract to ensure the adequate supply of wood fuel. Price is often a primary consideration for those considering wood heating. Facility managers, decision-makers, and community members often ask three main questions:

- 1) How much will the fuel cost?
- 2) Will the supply be reliable?
- 3) Where specifically will the fuel come from and will it be sustainably harvested?

While the last two questions are important, they go beyond the scope of this user guide and are discussed in-depth in the BERC handbook *A Buyer's Guide to Sourcing Woodchip Heating Fuel in the Northeastern U.S.* (<http://www.biomasscenter.org/pdfs/veic-sourcing-wood-heating-fuel-publication.pdf>). When selecting a supplier capable of making bulk deliveries to your area, there are points to consider in addition to price:

DELIVERY DISTANCE

Wood pellets and woodchips are most cost-effective when the distance by road between the manufacturer/distributor and the customer is fewer than 50 miles.

THE BULK MARKET

For pellets, it is best to go with a supplier that is committed to the development of the bulk market and will favor meeting orders for bulk deliveries over producing bags for residential sale.

GUARANTEED SUPPLY

Look for a supplier that guarantees an available and reliable supply.

SOURCE MATERIAL

Look for wood pellets that were produced from green woodchips or sawdust and avoid wood pellets that were made from construction and demolition (C&D) waste. The ash produced from burning pellets made from C&D wood waste may not pass rules on hazardous waste materials. Burning C&D wood may result in emissions that do not meet state and federal regulations. The ash from green woodchips and sawdust, however, will comply with the Vermont's solid waste management rules, as long as the annual ash production is below the regulatory threshold (only the largest installations fall above this threshold), and it will also likely meet any additional local requirements. You can obtain a written statement of the source of wood being used from your pellet manufacturer.



9 Resources Available to Affordable Housing Providers

Potential Source for Grants and Loans

As discussed in [Chapter 7 – Economic Performance, Grants and Loans](#), the following sources, among others, may offer grants and loans for the installation of modern wood heat systems:

Grants

- » Vermont Housing and Conservation Board: vhcb.org/housing.html
- » USDA Rural Development: rd.usda.gov/vt
- » Vermont Clean Energy Development Fund: publicservice.vermont.gov/renewable_energy/cedf

Rebates

- » Efficiency Vermont: efficiencyvermont.com/rebates
- » Vermont Clean Energy Development Fund, Small Scale Renewable Energy Incentive Program (CEDF SSREIP): rerc-vt.org/

Loans

- » USDA Rural Development: rd.usda.gov/vt
- » Rural Utilities Services (RUS): efficiencyvermont.com
- » Vermont Economic Development Authority (VEDA): veda.org

System Vendors and Engineers

It is extremely important that the wood pellet or woodchip boiler is sized properly. The boiler should be capable of providing enough heat to keep the building warm during the coldest hour of the year (“peak heating demand”). The peak heating demand depends upon both the efficiency of the building and the climate in which it is located.

It is usually most helpful to hire an engineer only after a pre-feasibility study has been completed and the decision has been formally made to go-ahead with installing a wood heating system.

A wood heating system vendor or a mechanical engineer can recommend a system with the right capacity for your building’s heating needs.

A mechanical engineer can also provide additional services, including:

- » Providing a detailed capital cost estimate,
- » Assessing the hydronic system requirements or any special requirements the facility may have,
- » Developing bid and specification documents,
- » Designing the system in conjunction with the system vendor, architect, and general contractor.

Information useful to have on hand prior to contacting system vendor or a mechanical engineer includes:

- » An energy loss analysis for your building to determine its ability to retain heat and quantify its peak heating requirement, if available
- » Several years of heating bills showing monthly fuel consumption
- » Total fuel consumption in a typical year, with monthly fuel consumption during peak winter months

A mechanical engineer, system vendor, or other design contractor will be able to help you with collecting and analyzing this information and assist you by recommending an appropriate boiler size for your facility's heating needs. Typical engineering and design fees can range from 10-15 percent of the total project cost, although system vendors may not charge directly for this service.

System Vendors List

Below is the list of active wood fuel suppliers with local representation at the time of the writing of this guidebook. The VT SWET team does not endorse any distributor; this list is only provided for information and is not intended to be a comprehensive list of all existing boiler manufacturers in the marketplace. Other suppliers may be available.

Pellet System Vendors

NAME / LOCATION	BOILER MFG	WEBSITE
Caluwe, Inc. Burlington, MA	Windhager (Austria)	windhager.com
Evoworld Troy, NY	Evoworld (Austria)	evoworldusa.com
Kedel Portland, ME	Blackstar (Denmark)	kedelboilers.com
Maine Energy Systems Bethel, ME	OkoFen (Austria)	maineenergysystems.com
Pellergy Montpelier, VT	Pellergy (USA)	pellergy.com
SunWood Biomass Waitsfield, VT	Fröling, Viessmann, Garn, Scandtec, & ACT BioEnergy	sunwoodbiomass.com

Woodchip System Vendors

NAME / LOCATION	BOILER MFG	WEBSITE
ACT Bioenergy Schenectady, NY	ACT bioenergy (USA)	actbioenergy.com
AFS Lemoyne, PA	AFS (USA)	afsenergy.com
Caluwe, Inc. Burlington, MA	Heizomat (Germany)	heizomat.de
Froling Energy Peterborough, NH	Froling, OkoFen, and Viessman	frolingenergy.com
Hargassner Sainte-Victoire-de-Sorel, QC	Hargassner (Austria)	hargassner.at
Hurst Coolidge, GA	Hurst (USA)	hurstboiler.com
McCormick Energy Dexter, ME	Schmid (Switzerland)	schmid-energy.ch/en
Messersmith Bark River, MI	Messersmith (USA)	burnchips.com
Tarm Biomass Lyme, NH	Froling (Austria)	woodboilers.com
Troy Boiler Company Troy, NY	Evoworld (Austria)	evoworldusa.com
Viessmann Warwick, RI	Viessmann (Germany)	viessmann-us.com
Woodmaster Red Lake Falls, MN	Northwest Manufacturing (USA)	woodmaster.com



Cordwood System Vendors

NAME / LOCATION	BOILER MFG	WEBSITE
Garn St. Anthony, MN	Garn (USA)	garn.com
SunWood Biomass Waitsfield, VT	Froling (Austria)	sunwoodbiomass.com

Wood Fuel Distributor List

Below is the list of active wood fuel suppliers at the time of the writing of this guidebook. The VT SWET team does not endorse any distributor; this list is only provided for information.

Bulk Pellet Suppliers

NAME / LOCATION	WEBSITE
Bourne Energy Multiple locations in VT	bournesenergy.com
Lyme Green Heat Lyme, NH	lymegreenheat.com
Maine Energy System Bethel, ME	maineenergysystems.com
Sandri Energy Greenfield, MA	sandri.com
Vermont Renewable Fuels Manchester Center, VT	vermontrenewablefuels.com
 http://biomassmagazine.com/plants/map/pellet/	
 http://biomassmagazine.com/plants/listplants/pellet/US/	
 http://biomassmagazine.com/plants/listplants/pellet/Canada/	

Bulk Woodchip Suppliers

NAME / LOCATION	WEBSITE / PHONE
A Johnson Bristol, VT	vermontlumber.com
Catamount Forest Products Groton, VT	catamountforestproducts.com
Cerosimo Brattleboro, VT	cersosimolumber.com
Cousineau FP Henniker, NH	cousineaus.com
Gagnon Lumber Pittsford, VT	gagnonlumber.com
Ivan Maxwell Trucking Derby, VT	(802) 766-4964
Limlaw Chipping West Topsham, VT	(802) 439-5995

Other suppliers, such as sawmills and logging-chipping contractors, are available to deliver woodchips, a complete list of can be obtained from the Vermont State Wood Energy Team (SWET) Manager.

For more information on Vermont SWET, contact:

Paul Frederick,
VT Statewide Wood Energy
Team (SWET) Manager

VT Department of Forests,
Parks & Recreation
1 National Life Drive, Davis 2
Montpelier, VT 05620-3801

Phone: 802-777-5247
paul.frederick@vermont.gov

SWET Web Resources

- » VT Department of Forests, Parks & Recreation: fpr.vermont.gov
- » Biomass Energy Resource Center: biomasscenter.org
- » Housing Vermont: hvt.org
- » Renewable Energy Vermont: revermont.org

Other Relevant Publications

- » *Woodchip Heating Systems, A Guide For Institutional and Commercial Biomass Installations*: biomasscenter.org/pdfs/Wood-Chip-Heating-Guide.pdf
- » BERC video on fuel sourcing: youtube.com/watch?v=YDRmhpy_qe0
- » *A Buyer's Guide to Sourcing Woodchip Heating Fuel in the Northeastern U.S.*: biomasscenter.org/pdfs/veic-sourcing-wood-heating-fuel-publication.pdf
- » *Community roadmap to Renewable Woody Biomass Energy*: nhrcd.net/pages/communityroadmap.html

Forest Management Practices

- » Voluntary Harvesting Guidelines for Landowners in Vermont: fpr.vermont.gov/sites/fpr/files/Forest_and_Forestry/Your_Woods/Voluntary_Harvesting_Guidelines/VHG_FINAL.pdf
- » Example of the benefits of good forestry for wildlife: vt.audubon.org/foresters-birds
- » Comprehensive overview of forestry best management practices: extension.unh.edu/goodforestry/index.htm
- » The North East State Foresters Association Review of Biomass Harvesting Best Management Practices Guidelines: nefainfo.org/publications.html
- » Forest Guild's voluntary biomass retention guidelines for the Northeastern United States: forestguild.org/Publications.html#RP

Third-party Certification Systems

- » The American Tree Farm System (ATFS) is a network of family forest owners practicing sustainable forestry that meets third-party certification standards: www.treefarmssystem.org
- » Standards that cover forest management certification as well as the movement of harvested wood through the supply chain:
 - The Forest Stewardship Council (FSC): us.fsc.org
 - The Sustainable Forestry Initiative (SFI): sfiprogram.org

Case Study: Housing Trust of Rutland County



Courtesy/ Biomass Energy Resource Center

In 2013, the Housing Trust of Rutland County put the finishing touches on the renovations of one of its multifamily buildings. A unique component of this renovation and 3 other buildings in the Housing Trust’s quiver of properties is the included component of modern wood heating.

<p>Location Brandon, Vermont</p>	<p>OkoFEN Autopellet Boiler</p>	<p>Thermal output: Hot water</p>
<p>Materials and installation cost: Boiler & Storage Bin \$28,000</p>	<p>Heating load: Space heating and DHW for 22,000 ft²</p>	<p>Thermal storage: Tank tied into solar hot water storage tank</p>
<p>Fuel price: \$260-\$270 / ton</p>	<p>Heating capacity (output): 56 kW 91,000 Btu/hr</p>	<p>Indoor pellet storage bin capacity: 10 tons</p>

This rental unit features nine two-bedroom units and nine one-bedroom units with included heat and hot water. The rooftop of this newly renovated building features solar thermal collectors which are tied into a hydronic system fueled by an OkoFEN Autopellet Boiler. The system includes propane backup boilers. Dan Smith, with Housing Trust of Rutland County, indicated that these backup boilers have not run except when the pellet supply runs out. Even when Vermont temperatures dip to minus 20 degrees, the pellet boilers are meeting the building's heating and hot water requirements. Overall, Dan reported the systems are running great and the tenants love the idea of local wood heat. The only issue he has encountered is the bulk delivery service provider.

Initially, Housing Trust of Rutland County was sourcing its wood pellets through a partnership between Vermont Wood Pellet Company (VWPC) and Vermont Renewable Fuels (VRF). VWPC operates a small pellet mill producing roughly 16,500 tons of finished pellet fuel annually. They source 100% of their incoming pine roundwood from harvest operations within 30 miles of their mill. VWPC produces bagged pellet fuel and also produced pellet fuel supplied in bulk that was being delivered through a partnership with VRF. The partnership consisted of a VRF truck capable of pneumatic delivery picking up the bulk fuels from VWPC and delivering these pellets to its bulk pellet customers. Recently, VRF began manufacturing its own pellets, and this relationship has shifted.

Even with the challenge of sorting out nuances with supplier and delivery changes, when Dan was asked if he would do this project all over again, he didn't hesitate to exclaim, "Absolutely!"

Glossary

ASH CONTENT: The amount of ash produced during combustion relative to the amount of fuel fed into the wood pellet boiler. Ash content is one indicator of quality for wood pellet fuel. Ash content for wood pellets should be between 1 and 3 percent.

BIOMASS: Any biological material, such as wood or grass, that can be used as fuel. Biomass fuel can generally be burned or converted in systems that produce heat, electricity, or both.

BOLE: The main tree stem, exclusive of branches and leaves.

BRITISH THERMAL UNIT (Btu): A unit used to measure the quantity of heat, defined as the quantity of energy required to heat 1 lb. of water 1° F. It takes about 1,200 Btu to boil 1 gallon of water.

DESIGN LOAD: Boiler output required to meet the maximum heating and domestic hot water needs of a given facility. This maximum heating load occurs during the few coldest hours of the coldest day of the year.

ENERGY CONTENT: The total Btu per unit of fuel. For biomass fuels, energy content can be considered on a dry or wet basis, since the amount of energy per pound of fuel is reduced with increasing moisture content.

FOSSIL FUELS: A group of combustible fuels used for energy production, such as oil, propane, coal, or natural gas, formed from the decay of plant and animal matter millions of years ago.

FUEL HOPPER: Temporary pellet holding area next to the boiler that typically holds just enough pellets for a day's worth of heat.

GLOBAL CLIMATE CHANGE: A term often used interchangeably with "global warming" that refers to the warming of the earth, and resulting climate change caused by the buildup of greenhouse gases (such as carbon dioxide, water vapor, methane and nitrous oxide) in the atmosphere. While these gases are naturally occurring, humans are increasing these amounts through burning fossil fuels and other activities.

HEATING DEGREE DAYS: A measure used to estimate energy requirements for heating. It is calculated by subtracting the average daily temperature in a given area from 65 degrees Fahrenheit (usually, or another building-specific temperature). Yearly totals can be used to compare the severity of the winter in different regions.

HIGHER HEATING VALUE (HHV) AND LOWER HEATING VALUE

(LHV): A measure of the energy content of perfectly dry wood (zero percent moisture content). Energy content can also be expressed as the lower heating value (LHV) or the net energy content after accounting for the wood's moisture content and further energy losses due to vaporization of water during combustion. LHV is determined by subtracting the heat of vaporization of the water vapor from the HHV.

HEATING LOAD: The amount of heat energy needing to be produced and distributed through a facility in order to maintain the facility's indoor temperature at a desired set-point.

HYDRONIC DISTRIBUTION SYSTEM: Centralized hot water heat distribution system providing heat to a building.

LIFE CYCLE COST: The total cost to purchase, own, and operate a piece of equipment over its entire life. The life cycle costs of several heating system options can be compared to determine which option will be the least expensive to own and operate over the entire expected life of the heating system.

MILLION BRITISH THERMAL UNITS (MMBtu): The amount of heat energy roughly equivalent to that produced by burning eight gallons of gasoline. An MMBtu is equal to a million Btu.

MODERN WOOD HEAT SYSTEMS: Modern, high-efficiency, clean-burning/low-emission energy systems that use wood products as fuel. These units are equipped with controls that are highly sophisticated and precisely modulate the amount of oxygen provided to the fire to ensure optimal burning. These systems are sized for the heat demand of the facility and result in limited air emissions. These systems are fully automated or semi-automated.

MOISTURE CONTENT: The total amount of water in a biomass fuel given as a percentage of the total weight of the fuel. Wood pellets, for example, typically have 6 percent moisture content, while woodchips have 40 percent (on a green weight basis) and heating oil has 0 percent.

NET PRESENT VALUE (NPV) OF SAVINGS: The difference, in current year dollars, between the value of the cash inflows and the value of the cash outflows associated with operating an energy investment. A positive NPV of savings indicates that, from society's economic perspective, the project is worth doing. A negative NPV of savings indicates that a project is not economically worth doing.

PARTICULATE MATTER (PM): Extremely small pieces of solid matter (or very fine droplets) ranging in size from visible to invisible. Relatively small PM— 10 micrometers or less in diameter—is called PM10. Small PM (such as PM 2.5) is of greater concern for human health than larger PM, since small particles remain airborne for longer distances and can be inhaled deeply within the lungs.

PULPWOOD: Lower grade of log that is suitable to be processed for paper manufacturing.

ROUNDWOOD: A general term for logs of varying grades.

SAWLOG: Grade of log that will be processed for lumber for products such as construction or furniture. Sawlogs are wider, straighter and have fewer knots than pulpwood.

SHORT-CYCLING: Term used to describe a boiler needing to turn itself on and off frequently, resulting in the fire in the combustion chamber needing to be re-started and left to burn out repeatedly, resulting in smoldering, lower efficiency, and higher emission of pollutants. Short-cycling is often the result of the boiler heating capacity being too large for the heat demand of the facility at that time.

A PRACTICAL GUIDE TO MODERN WOOD HEATING

SUCCESSFUL CONVERSION TO WOOD HEATING FOR AFFORDABLE HOUSING IN VERMONT

Prepared by the Vermont State Wood Energy Team with funding from the USDA Forest Service

