

The control algorithm was implemented on a digital signal processor and applied in real-time to regulate the output voltage of a 5 kVA laboratory synchronous generator

Fuzzy Logic Based Voltage Controller for a Synchronous Generator

Brock J. LaMeres,¹ M. Hashem Nehriri¹

An automated fuzzy logic based strategy controls the armature voltage of the generator by varying its field current in real-time

Fuzzy logic controllers are rapidly becoming a viable alternative for classical controllers. The reason for this is that a fuzzy controller can imitate human control processes closely. Fuzzy logic technology enables the use of engineering experience and experimental results in designing an embedded system. In many applications, this circumvents the use of rigorous mathematical modeling to derive a control solution. Another advantage of fuzzy logic control is that it allows for a model-free estimation of the system. In other words, the designer does not need to state how the outputs depend mathematically upon the inputs. A fuzzy controller can be developed by encoding the structured knowledge of the system, which will allow faster control algorithms to be developed in less time and at less cost. With the advance of microprocessors and digital signal processors (DSPs), fuzzy logic control techniques are becoming more attractive for real-time control problems. It is expected that it will be implemented in many power system control applications in the near future.

System Configuration

Figure 1 shows the block diagram for the proposed fuzzy logic-based closed loop control system. A three-

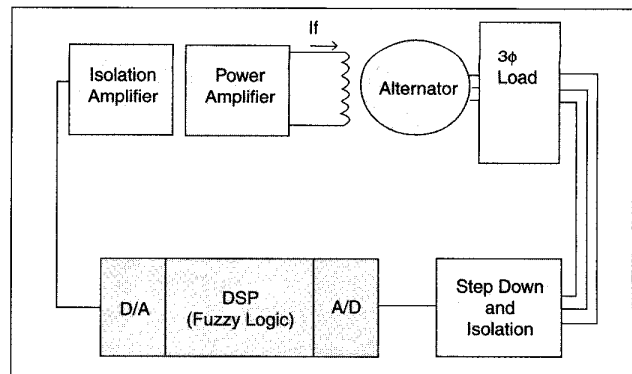

Figure 1. Closed loop control system

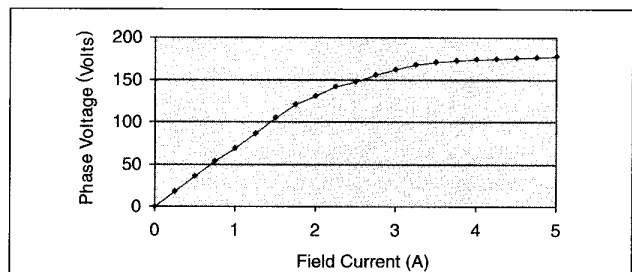

Figure 2. No-load saturation curve of the synchronous generator

¹ Montana State University

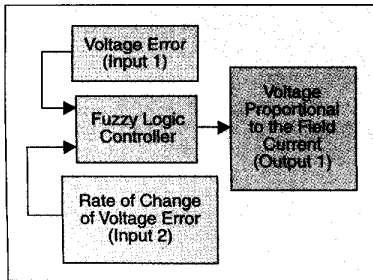

Figure 3. Variables of the fuzzy logic controller

phase, 5 kVA laboratory-size alternator, running at rated speed and rated armature voltage, experiences a varying three-phase load. As the armature voltage fluctuates with the changing load, the excitation current into the field of the generator must be altered to bring the armature voltage back to its rated value. This is accomplished with an intelligent fuzzy logic control strategy programmed into a Texas Instruments TMS320C5x DSP board. The terminal voltage of the alternator will be fed into a "step down and isolation" (20/1) stage, which will produce a signal that is suitable for the DSP (i.e., 0-10 V). This signal will first be converted from analog to digital using an onboard 12-bit signed A/D converter. At each sample point, the DSP will find the voltage error, which is the difference between the armature reference voltage (V_{ref}) and its immediate value (V_a). The DSP will then find the rate of change of voltage error at each sample point, which is the difference between the immediate and previous voltage error values. These two signals are used as input variables to the fuzzy logic controller. The controller's output is a digital signal that is fed into a 12-bit D/A converter giving an analog signal out (ranging from 0 to 10 V) proportional to the field current that is to flow through the alternator field winding. This signal is then fed into an isolation amplifier, which is an optocoupler that will provide additional isolation, and then to a power amplifier, before being applied to the alternator field winding.

Fuzzy Logic Controller

Fuzzy logic control is a nonmathematical decision algorithm that is based on an operator's experience. This type of control strategy is suited well for nonlinear systems such as the synchronous generator, which exhibits nonlinearity between the field current in and the armature voltage out. Figure 2 shows the no-load saturation curve of the 5 kVA synchronous generator to be controlled. The fuzzy logic controller can easily be programmed to handle the saturation effect.

The first input to the fuzzy logic controller is the immediate alternator phase voltage, stepped down with a ratio of 20 to 1. This "step down" stage will produce a signal that is suitable for the DSP. The second input to the controller is the rate of change of voltage that

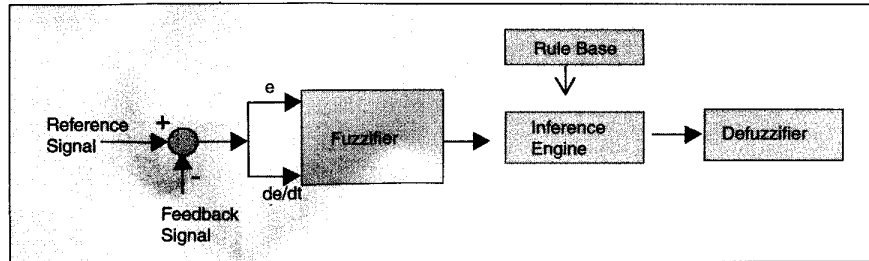

Figure 4. Structure of the fuzzy logic controller

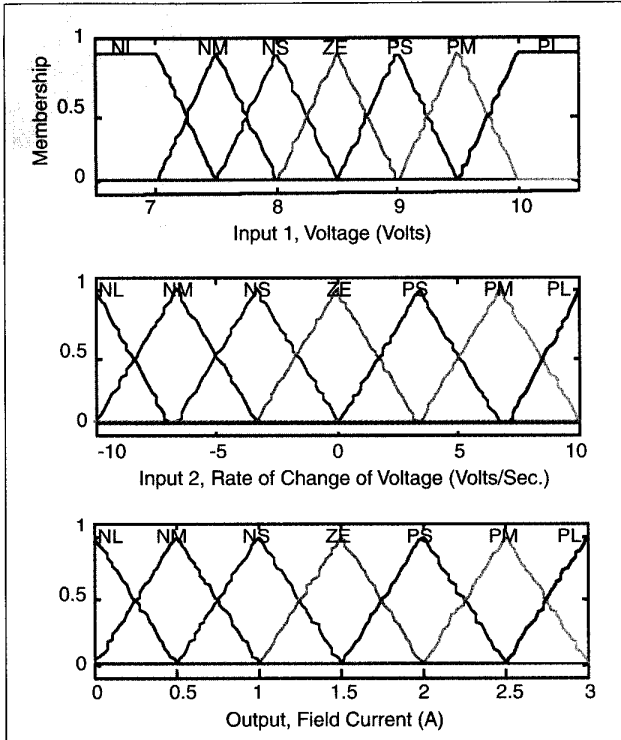

Figure 5. Membership functions of the fuzzy logic controller

describes how fast the output voltage is changing. This is an important parameter in a real-time control strategy for increasing the time response of the system. For example, the voltage may be 2 volts lower than its desired value. In one case, the output voltage is static, and a slight increase in the field current will bring the generator output voltage back to its desired level.

In another case, the output voltage may still be 2 volts lower than its desired value, but decreasing rapidly. For this situation, a larger field current must

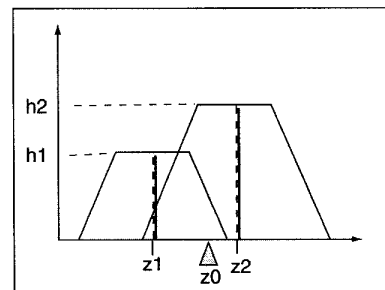

Figure 6. Weighted average defuzzification

be applied (at least temporarily) in order to bring the generator voltage back into control.

The fuzzy controller outputs a signal into the isolation amplifier and then the power amplifier that will change the alternator field current in order to regulate its output voltage. The block diagrams showing the variables of the fuzzy logic controller and its structure are given in Figures 3 and 4, respectively.

Fuzzification

Fuzzy logic uses linguistic variables as opposed to numerical variables. In a closed loop control system, the output voltage error and its time rate of change can be labeled with linguistic terms such as, negative large (NL), negative medium (NM), negative small (NS), zero (ZE), positive large (PL), etc.

In the real world, measured quantities are real numbers (crisp). The process of converting a numerical variable (real number) into a linguistic label (fuzzy number) is called fuzzification. Figure 5 shows the membership functions that are used to fuzzify the inputs. The inputs are mapped into membership functions, and a degree of membership shows to what degree each input belongs to a particular linguistic label. The membership can take on values between 0 and 1 for each of the linguistic labels. Once the membership is found for each of the linguistic labels, an intelligent decision can be made as to what the output should be. This decision process is called inference.

Inference

In the design of a conventional controller, there are "control laws" that govern the operation of the controller. In fuzzy logic control, the equivalent term is

"rule." Rules are linguistic in nature and allow the operator to develop a control decision in a more familiar human environment. A typical rule can be written as follows: IF the "voltage error" is positive large, AND the "rate of change of voltage error" is positive large, THEN the "field current" is positive large.

The rules of a fuzzy logic controller give the controller its intelligence, assuming that the rules are developed by a person who has experience with the system to be controlled. A programmer with more experience with the system will create a better controller. In the case of the fuzzy logic alternator voltage controller, it is desired to keep the alternator terminal voltage at its desired value under varying loads. Therefore, rules are made for every combination of voltage error and its rate of change to

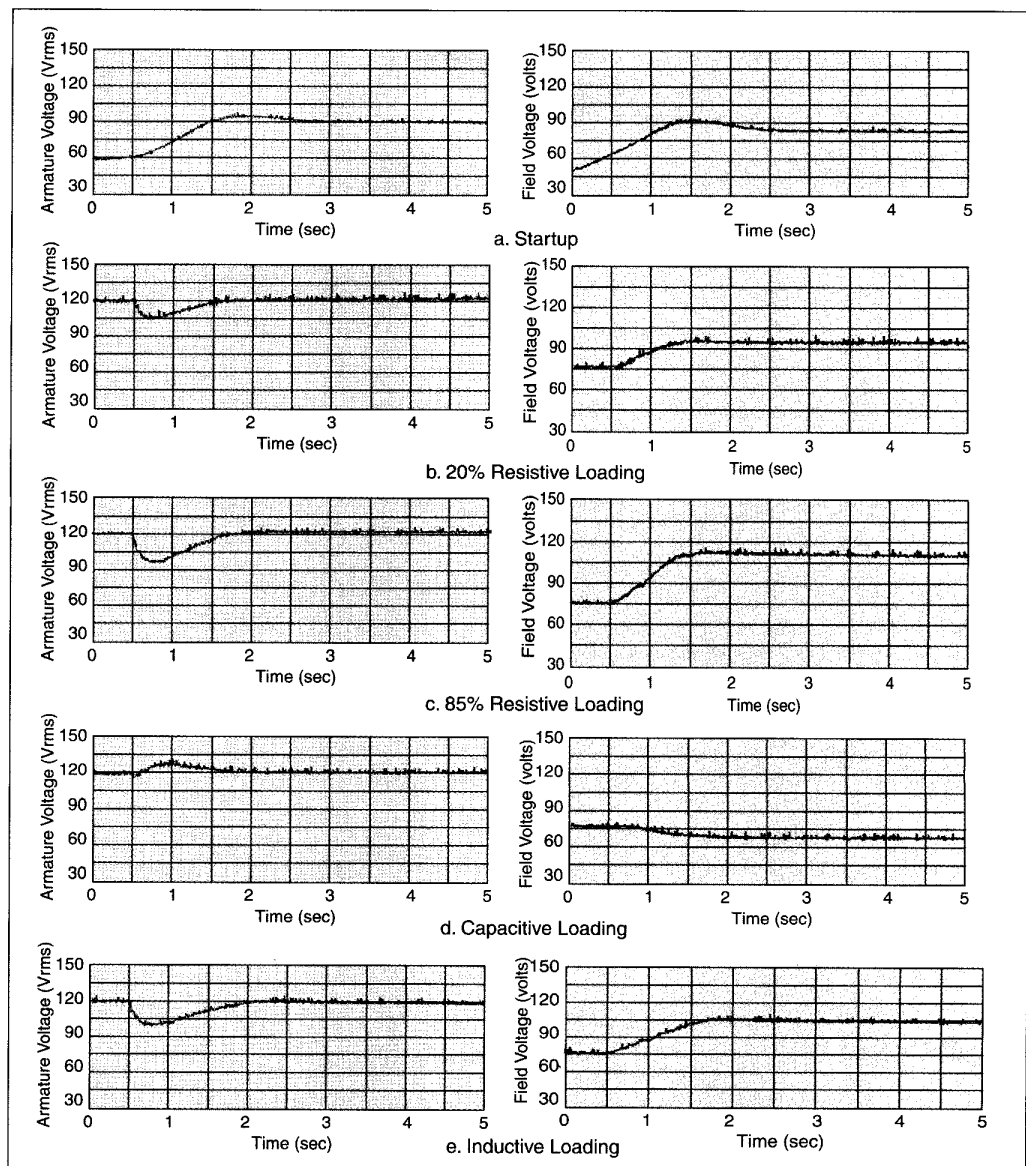

Figure 7. Armature and field voltage under startup and different sudden loadings

determine what the field current should be in order to effectively control the alternator output voltage. After the rules are evaluated, each output membership function will contain a corresponding membership. From these memberships, a numerical (crisp) value must be produced. This process is called defuzzification.

Defuzzification

Defuzzification plays an important role in a fuzzy logic-based control system. It is the process in which the fuzzy quantities defined over the output membership functions are mapped into a nonfuzzy (crisp) number. Several different methods exist to accomplish defuzzification, and there are tradeoffs to each method between accuracy and speed. The method chosen for implementation in this project was the weighted-average method, defined as the sum of the products of each membership function's center and height divided by the sum of all the membership functions' heights as follows:

$$Z_0 = \frac{\sum(z_i \cdot h_i)}{\sum h_i}$$

This method was chosen primarily for its speed. Figure 6 shows its graphical representation.

Implementation

The DSP board was the main piece of hardware used in this experiment. It contained the 12.5 μ s/12-bit A/D and D/A converters, the timer, and the 40 MHz, 32-bit processor. The synchronous generator used was a General Electric, 5 kVA, three-phase, 1,800 rpm, 120/208 V machine with a 1.5-A rated field current.

The step-down and isolation stage of the closed loop control system was implemented using a 20/1 Probe Master voltage attenuator. This stepped down the generator phase voltage from 120 to 8.5 Vrms. The peak value of this sinusoidal voltage was read by the DSP. In every cycle, 100 samples of A/D readings were taken, and the highest value was selected as the immediate peak voltage. The membership functions of the controller were centered on the detected peak voltage.

Once the fuzzy logic decision has been made according to the two inputs, the D/A converter would turn the output into an analog signal that could be fed to the power amplifier. The power amplifier would step up the output signal accordingly and provides the necessary voltage across the alternator field winding to generate the required field current.

The isolation amplifier used was a Burr-Brown opto-coupling device that provided additional isolation and safety. The power amplifier portion of the system was implemented using a Dayton Motor Control Power Amplifier.

The fuzzy logic control algorithm is programmed into the DSP and makes the intelligent decision of how

much field current is to be applied to the alternator field winding. Also, software was developed to run the DSP's hardware and its peripheral board. This software handles the A/D and D/A converters as well as the timers. All the code for the DSP was written in the TI C5x's assembly language.

Experimental Results

The controller was tested under startup and four different types of loads: a light resistive load (20 percent of rated), a heavy resistive load (85 percent), a capacitive, and an inductive load. In all cases, the fuzzy logic controller was able to bring and keep the output voltage of the generator to its desired value (120 V). Figure 7 shows the generator phase voltage and the voltage that the controller applies to the generator field winding in order to bring the phase voltage to its desired value during startup and as the above loads are suddenly applied.

Acknowledgment

This work was supported by the National Science Foundation, Grant ECS-9616631, and by Montana State University Engineering Experiment Station. The authors thank Dr. Giri Venkataramanan for providing technical input throughout the course of this project.

For Further Reading

A.E. Fitzgerald, C. Kingsley, S.D. Umans, *Electric Machinery* (Fifth Edition), McGraw Hill, 1990.

T.J. Ross, *Fuzzy Logic with Engineering Applications*, McGraw Hill, 1995.

M. Jamshidi, N. Vadiiee, T.J. Ross, *Fuzzy Logic and Control, Software and Hardware Applications*, Prentice-Hall, Inc., 1993.

A.R. Hasan, T.S. Martis, A.H.M. Sadrul, "Design and Implementation of a Fuzzy Controller Based Automatic Voltage Regulator for a Synchronous Generator," *IEEE Transactions on Electrical Machinery*, Volume 9, Number 6, September 1994.

Biographies

Brock J. LaMeres received his BSEE degree in 1998. In 1996, he interned for VeriBest Inc., an EDA development company. In 1998, he interned for Micron Technology Inc. He received recognition and several scholarships for his participation and achievements in undergraduate research. His primary areas of interests are digital signal processing, fuzzy logic control, and microprocessor applications. He was president of the student branch of Eta Kappa Nu honor society at Montana State University and a member of Tau Beta Pi, Phi Kappa Phi, and Golden Key honor societies. He accepted an engineering position with Hewlett Packard Company in Colorado Springs, Colorado, in January 1999, where he works in the hardware design group. He is an IEEE member.

M. Hashem Nehrir received his BS, MS and PhD degrees from Oregon State University in 1969, 1971, and 1978, respectively, all in electrical engineering. From 1971 to 1986, he was with the Department of Electrical Engineering at Shiraz University in Iran, where he became department chair in 1984. He was a visiting scholar at the University of Idaho during 1986-87. He joined the Electrical Engineering Department at Montana State University in 1987, where he is a full professor. His primary areas of interest are control and modeling of power systems and electrical machinery, renewable power generation, and fuzzy logic control applications to power systems. He is a member of Eta Kappa Nu and Tau Beta Pi honor societies and a senior member of IEEE.